



Newport 400c

Installation and Operating Manual

Z±ION ready with the Spectra Connect control system
System is equipped with Spectra's innovative new Connect control system and pre-plumbed for the patented Z±ION



Spectra Watermakers
Katadyn Desalination LLC.
2220 S. McDowell Blvd Ext. Petaluma, CA 94954
Phone: 415-526-2780 Fax: 415-526-2787

info@spectrawatermakers.com
www.spectrawatermakers.com

Updated January 2018

Spectra Connect Quick Start Guide

When you first power up the system, you will get a warning message, asking **if the system has been stored with chemicals**.

If the system has been pickled, winterized, this is the first startup, or the condition of the system is unknown, go to **COMMISSIONING** on page 23 or serious damage may occur.

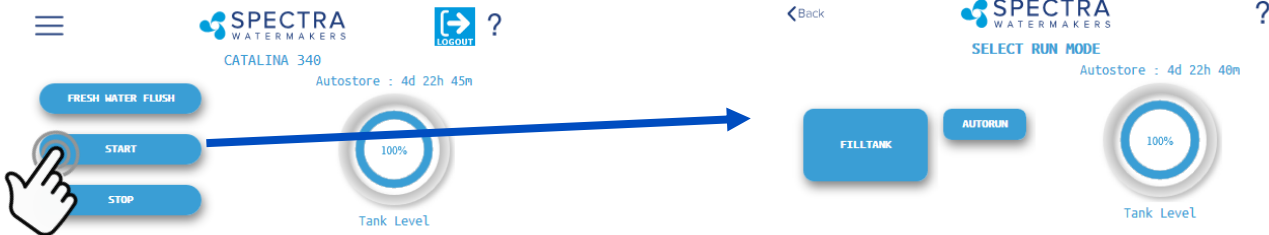

Start

Pressing the 'Start' button once advances to the Run Mode selection screen.

Run Mode

Select your desired Run Mode to start making water and filling your tanks. See details on Run Mode options on p. 37



Fresh Water Flush

Pressing the 'Fresh Water Flush' button flushes the watermaker with fresh water from the vessel's domestic water tanks. After completing the flush, Spectra Connect will automatically enter the Auto Store mode.



Stop

Pressing the 'Stop' button from the Home Screen will end the Auto Store mode countdown timer and leave your watermaker in Standby mode.

Spectra Connect Modes and Definitions

Auto Store: After the watermaker fresh water flushes, it will start a countdown timer that can be seen on the Home screen. The timer indicates the next programmed fresh water flush if the watermaker is not started again, or the 'Stop' button is not pressed.

Fill Tank: The watermaker will automatically run until the Tank Full switch in the water storage tanks closes. Once the Tank Full switch closes, the watermaker automatically fresh water flushes, then reverts to the *Auto Store* mode.

Auto Run: The watermaker can be set to run for a number of hours, or for a quantity of water to be produced. When the desired quantity of water is produced or the run timer expires, the watermaker will Fresh Water Flush and enter the *Auto Store* mode.

Thank you for your purchase of a Spectra Newport 400c system. When properly installed and maintained, it will provide years of trouble free service. Professional installation is strongly recommended. Like any piece of mechanical equipment, the system will require inspection and service, so plan ahead for service access and install “service loops” in cabling. If a dealer is installing the system for you, review the location of the components to ensure the installation will meet your approval upon completion.

Newport Installation Quick Start Important Details for Installer

1. The system must have a dedicated sea water inlet to guarantee a constant flow of water to the system. The inlet should be as low in the boat as possible with a dedicated, forward-facing scoop-type thru-hull fitting.
2. Both the Newport 400c feed pump module and the Clark Pump/Membrane module must be installed in a well ventilated compartment where **temperatures will not exceed 113°F (45°C)**. Many engine compartments exceed this temperature when underway. Warranty will be void if the installation does not meet this requirement.
3. Follow the wire gauge charts in the instructions! Using larger wire than specified is acceptable.
4. If you are separating the Clark Pump/membrane assembly, please review the high pressure tube assembly instructions. Improper assembly will cause failure!
5. Run, test, then sea trial the complete system before assuming it is operational. If the boat is in fresh or dirty water, see Dry Testing the System. After testing, make sure the flush cycle operates properly. The water going overboard at the end of the flush should measure <1000 PPM Total Dissolved Solids.
6. The Spectra Connect control must have DC power continuously to achieve the full benefits of the fresh water flush system. The domestic fresh water pressure must be on and the fresh water tank level maintained. Calculate about 7 gallons (27 liters) per flush.
7. The Spectra Connect control must be de-powered (DC power off) after the system is pickled or winterized.
8. Spectra dealers are responsible for educating the vessel owners on the operation and maintenance of the system. Please walk through the entire installation with our customer.
9. The equipment owner should fill out the warranty card or register online.

Table of Contents

Getting Started	7
Installation Basics	8
Components	9
Newport Plumbing Schematic.....	11
Plumbing Detail	12
Tube Fitting Assembly Procedures	14
Electrical.....	17
Tank Switch Wiring and operation	20
Optional Tank Level Sensor Installation	22
Operation	
New Systems Start Up and Testing	23
Dry Testing with an Artificial Ocean	25
Sensor Calibration	26
Tank Level Sensor Calibration	28
Salinity Calibration.....	30
Product Flow Calibration	31
Networking.....	32
Normal Operation	34
Maintenance, Storage, and Troubleshooting.....	
Maintenance	39
Introduction to Spectra Chemicals.....	42
Storage Procedures	44
Winterizing with Propylene Glycol	45
Membrane Cleaning Procedure	46
Suggested Spares.....	47
Troubleshooting	48
Alarm Override and Manual Operation.....	51
Newport 400 Flow Test.....	52
Poor Water Quality.....	54
Technical Bulletins.....	55
Spectra Connect Programming & Controls.....	
Introduction	59
User Settings & Fault Alarms.....	60
Dealer Access Settings	61
Wiring Schematics	65
Electrical Specifications	66
Exploded Views and Part Numbers.....	67

Installation Notes...

Getting Started

Unpack the system and inspect it to make sure that it has not been damaged in shipment. Freight damage must be reported to the carrier within 24 hours.

Refer to the shipping list for your system to make sure you have received all of the components listed. Do not discard any packaging until you have found and identified all of the parts. The smaller installation parts are listed on the plastic bags' pick list.

We will not be held responsible for shortages not reported within thirty days of the ship date. Damaged equipment must be reported within 24 hours.

Study the system layout diagram, component photos, and descriptions before beginning your installation.

Lay out the system. Ensure that there is clearance around the components for removal of filters and system service. Make sure you have adequate tubing, hose, and cable before starting. Additional parts may be ordered.

Newport 400c shipping list:

- Newport Feed Pump Module
- High Pressure Clark Pump and Reverse Osmosis Membrane Module
- Fresh Water Flush Module (or optional Z-Ion)
- Installation Kit, with black and blue product tubing
- Boost Pump Module
- Newport Service Kit
- Inlet Hose Assembly
- 3/8" flush cycle tube (25' black)
- 5/8" vinyl braided hose (25')
- 3/4" suction hose (25' black spiral wound)
- 3/4" vinyl braided hose (10')
- 1/2" Feed pump to strainer hose (15', with quick disconnect)
- 1/2" Feed water inlet hose (10' with ends pre-fitted)

Installation Basics

- **Read the directions!**
- Avoid tight hose bends and excessive hose runs.
- Use heavy gauge wire.
- Install the feed pump module as low as possible.
- The boost pump module must be installed below waterline.
- Use a dedicated thru-hull with scoop-type strainer.
- Do not mount components over electrical devices.
- **Avoid getting dirt or debris into the piping or hoses during assembly.** A small bit of debris can stop the system!

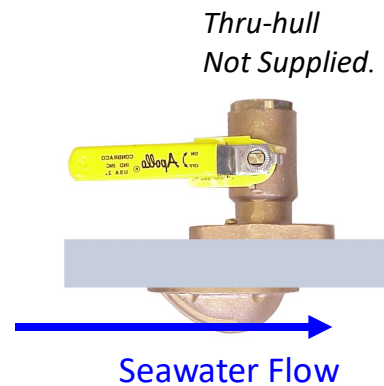

Thru-hull Type and Location: The system must be connected to a dedicated 3/4" to 1" forward-facing scoop-type intake thru-hull and seacock.

Install the thru-hull intake as far below the waterline and as close to centerline as possible to avoid contamination and air entering the system. Do not install the intake close to or downstream of a head discharge, or behind the keel, stabilizer fins, or other underwater fixtures.

Thru-hulls in the bow and stern areas are susceptible to air intake in rough conditions. Sharing a thru-hull can introduce unforeseen problems such as intermittent flow restrictions, air bubbles, contaminants, and will void the warranty. For racing boats and high speed boats traveling above 15 knots, a retractable snorkel-type, or high speed thru-hull fitting is preferred because it picks up water away from the hull.

The brine discharge thru-hull should be mounted above the waterline, along or just above the boot stripe, to minimize water lift and back pressure.

Double clamp all hose connections below the waterline.

Avoid restrictions or long runs on the entire inlet side of the plumbing from the thru-hull to the feed pump module.

Secure the piping away from moving objects such as engine belts and hatches. Prevent chafe on the tubing as required. Test and inspect all piping and hose clamps after several hours of operation.

Pipe Fitting Instructions: To seal plastic-to-plastic fittings, wrap 6 to 8 layers of Teflon tape over the male pipe threads. Tightly wrap the male threads clockwise. For smoother assembly, do not tape the first (starting) threads.

Wiring

- Pay attention to wire size or system performance will be impaired
- Perform wiring to UL, ABYC, CE or applicable standards

Components

Sea Strainer and Boost Pump Module: Mount close to the intake through-hull, below the waterline, in a location that can handle water spillage during service. The boost pump power cable will connect to the feed pump module.



Fresh Water Flush Module: The fresh water flush module may be located in any convenient location near the feed pump module. It should be mounted with the filter housing vertical and accessible, with 2" below the housing for filter changes. Do not install over electrical equipment. The unit contains the charcoal filter, a solenoid shut off valve, and a flush water flow regulator.



IF INSTALLING THE Z±ION, SEE Z±ION INSTALLATION INSTRUCTIONS FOR MORE DETAILS.

Feed Pump Module

Mount the feed pump module on a vertical surface, up to 3-feet (1.0M) above the waterline. It is preferable to mount as low as possible. Locate in an area that allows easy access to both the filters, and the left hand side of the enclosure. Keep future maintenance in mind when choosing a location, and do not mount above water-sensitive equipment. The feed pump has overheat protection and will not operate properly at ambient temperatures over 113°F (48°C).



Remove the 6 Philips screws on the front cover (three on shown side and three on the other) to access the mounting holes in the back of the enclosure.

Components continued...

Remote Touchscreen

The remote control panel can be mounted anywhere dry and convenient. Cut a 5-5/8" (12.7 cm) wide by 3-1/4" (7.62 cm) high opening for the panel. The display needs minimum 2 1/2" deep clearance for the cable. Take care not to damage the plugs on the ends of the cable when routing. **Use only a Spectra-approved cable.**

***Also available as an optional local display**



Clark Pump and Membrane

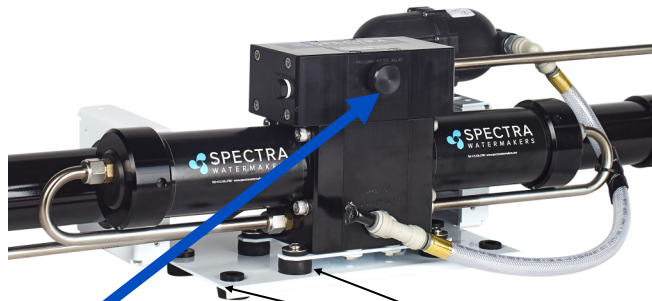

Pressure Relief Valve

Double rubber mounts
to absorb vibration

This module must be installed in an area that maintains a temperature below 113°F (45°C). It may be placed as high in the boat as you desire, and mounted in any position, even upside down. Make sure that the area around and under the pump does not have any water sensitive equipment, as water will be spilled during any repairs or if a leak occurs. Allow for easy access to the pressure relief valve.

The Clark pump and membrane module comes complete with a mounting system. Be sure to use the supplied washers on the rubber feet.

Plumbing Schematic

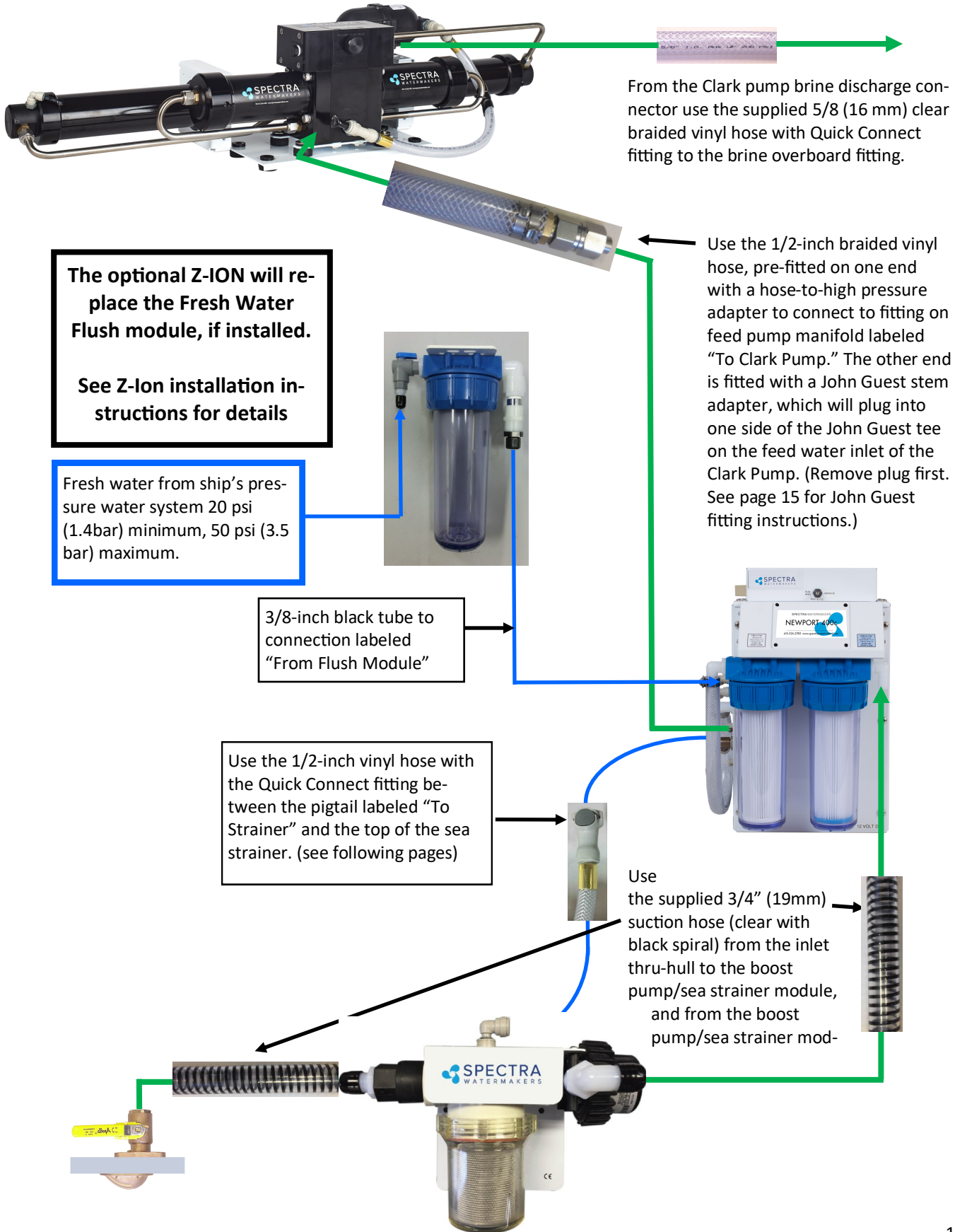

Plumbing Detail

Note! When plumbing the Newport feed pump module, route the feed water hose so that the front cover may be opened without removing the hoses or tubing.

Allow access to the left side of the feed pump module for attaching tubing and operating the manual button on the diversion valve.

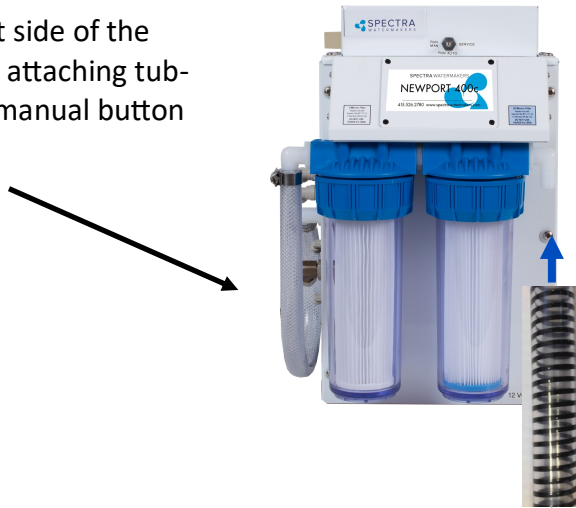

Feed water inlet from boost pump. Leave enough extra length in this hose to allow the front cover to be moved aside for service access to the inside of the box.

Manifold (Left side of feed pump module):

- Flush water inlet from charcoal filter
- To strainer
- Feed water inlet from filters
- Product water outlet to tank
- Feed water outlet to Clark pump
- Product inlet from membrane

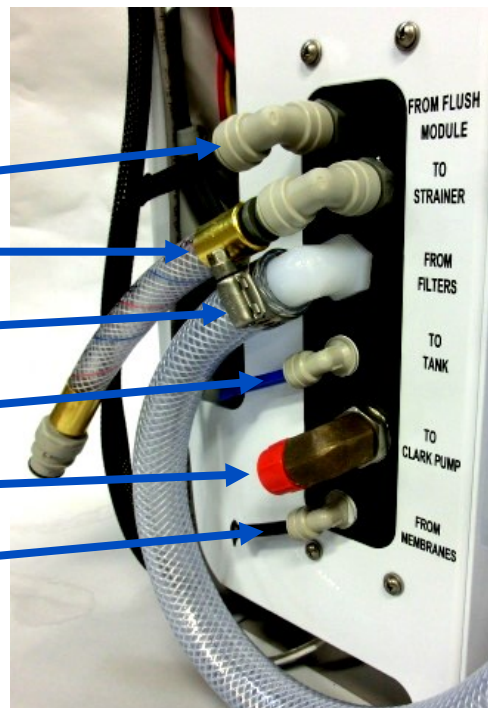

Plumbing Detail continued...

Product Water Tubing

The Product water tubing is 1/4-inch (6.3mm) Parker tubing. Product water goes from the membrane into the Feed Pump Module manifold where it passes through the flow meter, the salinity probe, and the diversion valve. If the salinity is below the set threshold, the diversion valve energizes and the product water is sent to the tank from the manifold product outlet. If the diversion valve is not energized the product goes back into the feed water.

Connect the product outlet on the membrane end plug to the product inlet fitting on the pump module manifold using the supplied 1/4-inch **black** nylon tubing.

Route the **blue** product water tube from the **blue** product water outlet fitting on the Feed Pump Module manifold into the top of the water tank. Install a tee in the water tank fill or tap a pipe thread into an inspection port in the top of the tank. Do not feed the water into a manifold or bottom of the tank. Make sure there is no restriction or back pressure in this plumbing.

If the length of product water tubing supplied with the watermaker is insufficient, use a larger size hose. **Product water flow restriction will cause reduced production and increased power consumption.**

Warning! Never install a shutoff valve on the product water tubing to fill the tank, serious damage can occur!

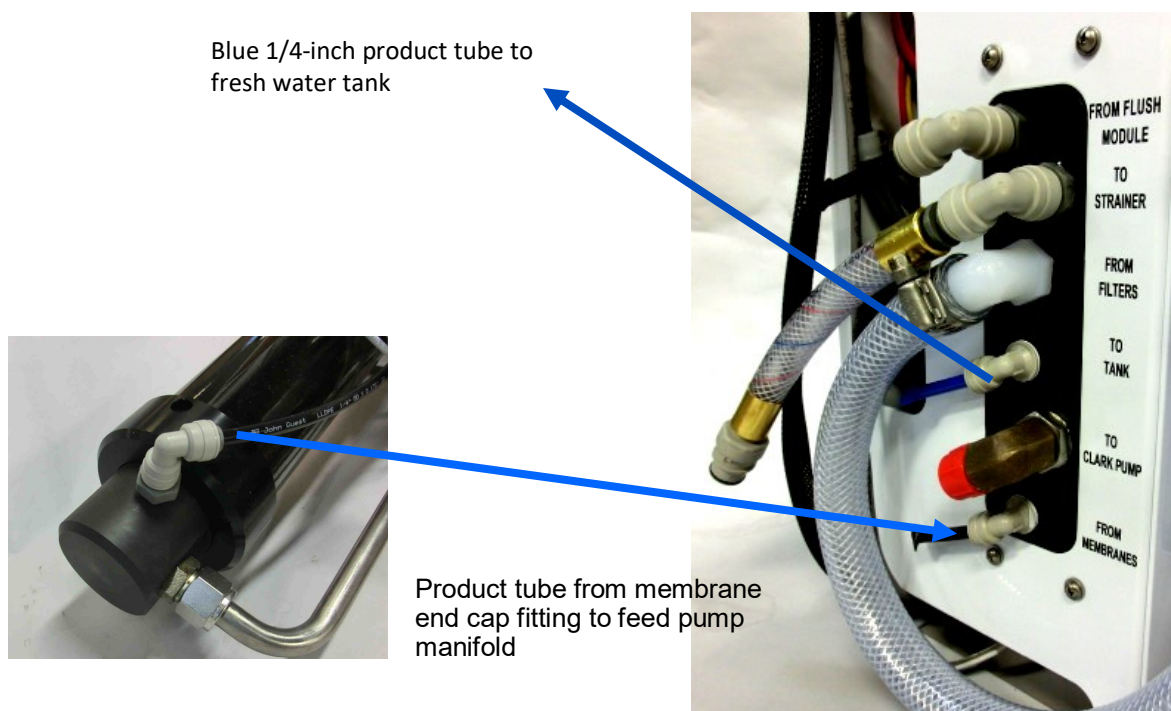

Plumbing Detail continued...

Brine Discharge

Route the Brine discharge from the quick disconnect fitting to a location above the waterline using the supplied 5/8" hose.

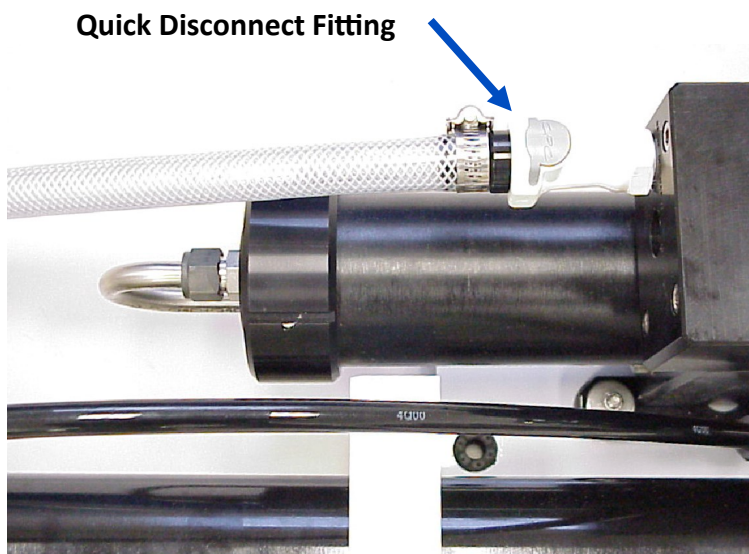

Fresh Water Flush

Run a hose/tube from the pressurized domestic cold water system to the 1/2" inlet hose barb on the fresh water flush assembly or Z-ION. This needs to be pressurized when the boat is unattended for the fresh water flush system to function properly. **The domestic fresh water pump must be able to deliver 1.5 gallons per minute (5.5 LPM) at 30 PSI (2 Bar).**

If the optional Z-ION was purchased, it will be installed in place of the Fresh Water Flush module.

See Z-Ion installation instructions for details.



Fresh water from boat's pressure water system

To Flush water Inlet on pump module manifold using supplied 3/8" tubing.



Fast & Tite® Thermoplastic Fittings

Fast & Tite® fittings are the most complete line of plastic fittings for thermoplastic tubing in the industry.

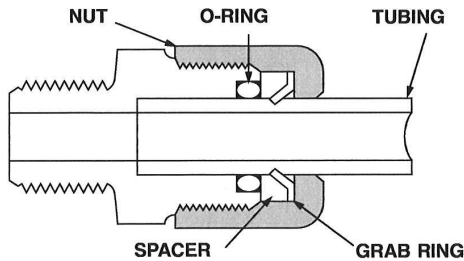

Fast & Tite® thermoplastic tube fittings from Parker will prove to be the answer to your tubing connector needs. Patented Fast & Tite® fittings install in seconds without tools and provide a tight, sure, leak proof seal without clamps or adjustments. A unique 302 stainless steel grab ring for tube retention, coupled with a Nitrile O-Ring for positive seal, assures good tube connection with only hand tight assembly. A plastic grab ring is also available upon special request. Vibration or tube movement will not break the seal and cause leakage. Preassembled in either highly inert polypropylene, or strong, durable nylon, Fast & Tite® fittings are the answer to full flow thermoplastic tubing system requirements.

When necessary, Fast & Tite® fittings can be disassembled by hand for fast system drainage. Fittings are completely reusable.

Parts are easily replaced. O-Rings are standard size and universally available. (For applications requiring other than Nitrile O-Rings, consult your Fast & Tite® distributor.)

Use Fast & Tite® fittings with Parker Parflex tubing or other plastic, glass or metal tubing for low pressure or vacuum lines up to the pressure limits shown below.

Fast & Tite® fittings meet FDA and NSF-51 requirements for food contact.

Working Pressures for Fast & Tite® Fittings

Tube O. D., in.	Air-Oil-Water Pressure in PSI		
	Up to 75°F	76° to 125°F	126° to 175°F
1/4	300	300	300
5/16	300	300	300
3/8	250	250	150
1/2	200	200	150
5/8	150	100	50

Ratings are based on use with copper tubing, and in all cases represent the maximum recommended working pressure of the fitting only. Working pressures (vs. temperatures) of other types of tubing may limit the tube and fitting assembly to pressures lower than shown above. Consult factory for recommendations on applications other than shown above.

Temperature Range:

Black/White Polypropylene: 0°F (-18°C) to +212°F (+100°C)

White Nylon: -40°F (-40°C) to +200°F (+93°C)

Fast Assembly

Step 1.

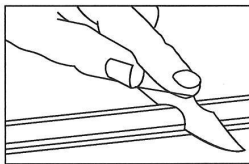

Cut the tube squarely and remove any burrs.

Step 2.

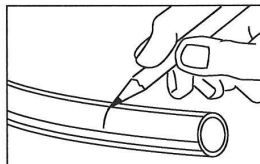

Mark from end of tube the length of insertion. (See table below)

Tube O.D. (in.)	Insertion Length with Tube Support (in.)	Insertion Length without Tube Support (in.)
1/4	5/8	9/16
5/16	5/8	9/16
3/8	13/16	3/4
1/2	7/8	13/16
5/8	1	15/16

Step 3.

Loosen nut on fitting until three threads are visible. Fittings for glass tubes must be disassembled and the grab ring removed.

Step 4.

Moisten end of the tube with water. Push the tube **Straight** into fitting until it bottoms on the fitting's shoulder. Tighten nut by hand. Additional tightening should not be necessary, but 1/4 additional turn may be added if desired. **Do not overtighten** nut as the threads will strip and the fitting will not function properly. A proper assembly will not show the insertion mark extending beyond the nut. If the insertion mark is visible, then steps 1 thru 4 must be repeated.

Step 5.

When using clear vinyl tubing or urethane tubing, it is necessary to use a **TS** tube support. Disassemble the fitting and place the nut, grab ring, spacer and tube support, in that order on the tube. Locate the grab ring at the insertion mark as shown. Seat the O-ring in the body, then proceed with Step 4.

Note: Provide adequate fail-safe mechanisms such as leakage detection sensors, automatic shut-off controls or other industry and code appropriate fail-safe devices in the design of your water-handling appliance to protect against personal injury and property damage.

Plastic fittings containing an o-ring that are used in water applications should be replaced at least every five years or more frequently depending on the environment and severity of the application.

John Guest Super Speedfit Fittings

How Super Speedfit Works

To make a connection, the tube is simply pushed in by hand; the unique patented John Guest collet locking system then holds the tube firmly in place without deforming it or restricting flow.

Materials of construction

Super Speedfit fittings are made up of three components:

Bodies are produced in an acetal copolymer or polypropylene.

'O' rings are Nitrile rubber or EPDM.

Collets are produced in acetal copolymer or polypropylene with stainless steel teeth.

How to make a connection

Cut the tube square

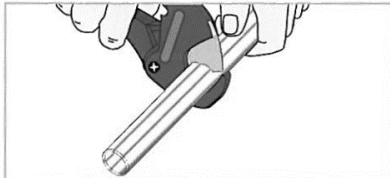

Cut the tube square and remove burrs and sharp edges. Ensure the outside diameter is free of score marks. For soft or thin walled tube we recommend the use of a tube insert

Push up to tube stop

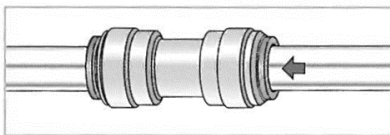

Push the tube into the fitting, to the tube stop.

Pull to check secure

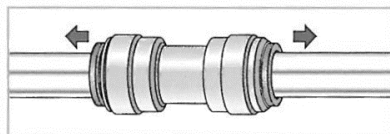

Pull on the tube to check it is secure. Test the system before use.

Grips before it seals

'O' ring provides a leakproof seal

The Collet (gripper) has stainless steel teeth which hold the tube firmly in position while the 'O' ring provides a permanent leakproof seal.

Collet

Stainless steel teeth grips the pipe

To disconnect

Push in collet and remove tube

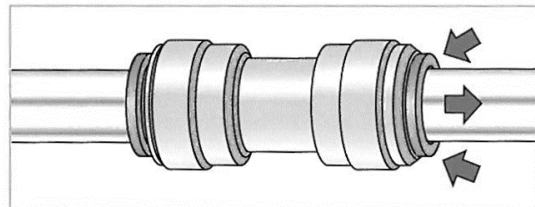

To disconnect, ensure the system is depressurized, push the collet square against the fitting. With the collet held in this position the tube can be removed.

Electrical

The Newport 400c has a power inlet harness with a terminal block and cover, a boost pump power plug with a yellow band, 5 wire conductor cable for the tank full switch and the optional tank level sensor, and a short plug with a green band for the optional Z-Ion.

Do not install it in hot or poorly ventilated locations. Allow access to the motor speed control.



Power inlet harness

5 Conductor wire:
Tank Full Switch,
Green + Orange

Tank Level sensor
5vdc: Red
Signal: White
Ground: Black



Z-ION Connector (with green band). Left unused if your system was not ordered with the optional Z-ION.

Boost pump cable



Run Auto/Manual/Service toggle switch

Motor speed controller (above the motor, under the lid of the box)



Electrical continued...



Connect the yellow boost pump connector from the Spectra Connect housing to the corresponding connector routed from the boost pump.



Mount the main power terminal block in a junction box or on a bulkhead adjacent to the feed pump module. Make sure that this is a dry location well above bilge level and not subject to water spray. **Be sure to install the terminal block cover.**

Check the wire size chart for appropriate wire sizes. DC power feeds should be uninterrupted to insure proper operation of the auto store feature. Avoid house breaker panels that could be accidentally tripped.

Component Sizing:

- 12-Volt: Use a 30 Amp breaker and size the wiring for 25 Amperes.
- 24-Volt: Use a 15 Amp breaker and size the wire for 13 Amperes.
- Provide circuit protection at the source! Undersized wiring will reduce system performance.

Wire Size Guide for the Newport 400c 12 Volt:

8 Gauge (10mm²) up to 15 feet (4.5M)

6 Gauge (16mm²) up to 20 feet (7.6M)

4 Gauge (25mm²) up to 35 feet (14M)

Wire Size Guide for the Newport 400c 24 Volt:

8 Gauge (10mm²) up to 30 feet (10.6M)

6 Gauge (16mm²) up to 45 feet (14M)

Distances at left represent the total **ROUND TRIP** wire length (DC positive length plus DC negative length), **NOT** the length of the pair of wires together. Size cables accordingly.

Note: If the specified circuit breaker sizes are unavailable, use the next higher rating but do not exceed the specification by more than 10%. All wiring to be done to applicable ABYC, Marine UL, or CE standards.

Installing the Remote Display



Route the cable through the vessel in the most direct route possible. Avoid kinking the wire, or sharp corners where the wire can chafe through while the vessel is under way.

Turn power OFF to the system.

Connect the ethernet cable to back of the display in the open jack.

Connect the opposing end of the ethernet cable to the RJ12 port labeled "DISPLAY" on the feed pump module.

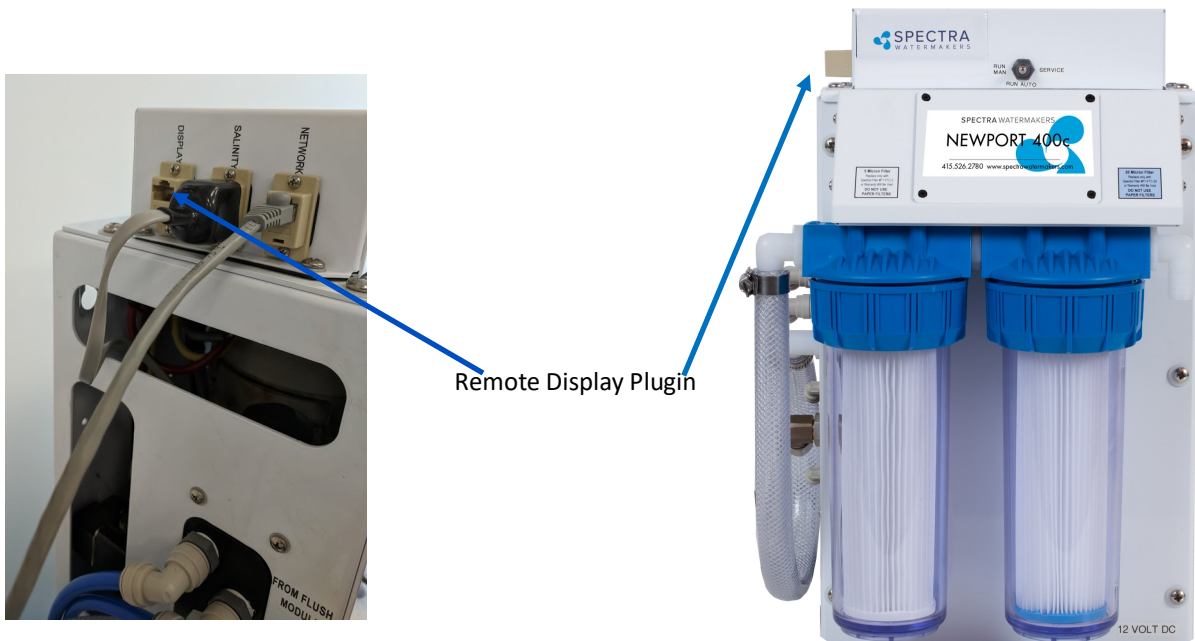

Turn Power ON to the system.

The display will start automatic firmware upload. You can see the upload status on the screen. The process typically takes 10 minutes to complete.

At the end of firmware upload, you will be asked to confirm the display update. Press "OK".

If the error message "firmware upload failed" appears, check your connections at the control board, and cycle power on the watermaker.

Tank Switch Installation

Factory Supplied Tank Full Switch

Installing the supplied tank full float switch at the top of your water tank allows the Spectra Connect to fill your water tank then automatically stop, fresh water flush and return to Auto Store mode with no additional user commands.



Drill and tap a 1/8" npt port into the top of the fresh water tank that is being filled by the watermaker. This can be installed on a tank access cover, or directly into the water tank. If installing on an access cover, be sure to leave a service loop on the float switch wiring to allow removal of the tank access cover.

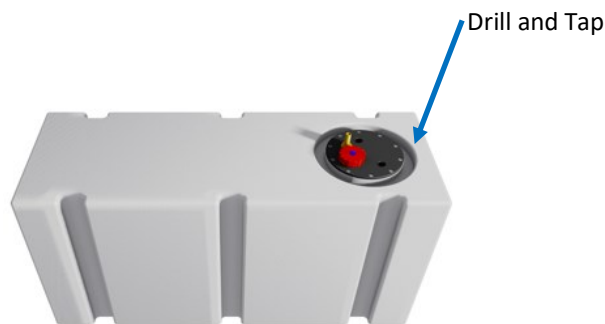

The supplied float switch must be connected to the **Green and Orange** conductors at the Feed Pump Module, labeled **Tank Full Switch**. There is no polarity.

Use 18/2 tinned wire or larger. Wire is not included in the installation kit.

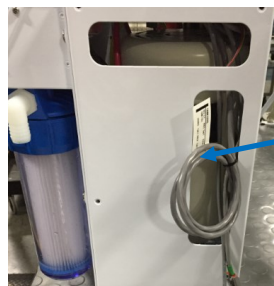

Connect to Gr/
Or wires



For Instructions on 'Auto Fill' mode and installing a Tank Low switch, see 'Auto Fill' mode instructions later in this manual.

Watermakers should never be run unattended.

Your watermaker comes with the top-mounted Tank Full Switch (EL-SWT-LV) and is designed to be mounted to the top of the water tank. The side-mounted float switch (EL-SWT-SMLV) can be sourced from your local dealer or Full Service Provider if you cannot access the top of your tank.

If you do not install the Tank Full switch in your tank, you MUST DISABLE the Tank Full Switch in the system settings. See System Settings instructions later in this manual.

Tank Switch Installation

Optional Tank Low Switch

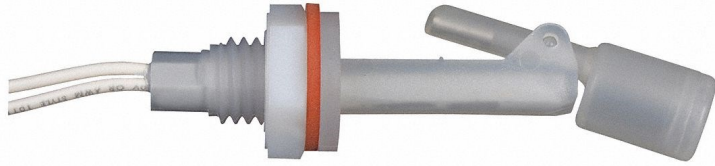

Installing the tank low float switch about 2/3rds down from the top of your water tank allows the Spectra Connect to run in Auto Fill mode; automatically filling your water tank, stopping itself, fresh water flushing, returning to Auto Store mode, and then turning itself on again to fill the tank when the water level drops below the Tank Low Switch with no additional user commands.

Drill 5/8" hole into the side of the fresh water tank that is being filled by the watermaker. This can be installed wherever there is convenient access to the tank, approximately 2/3rds of the way down from the top of the tank.

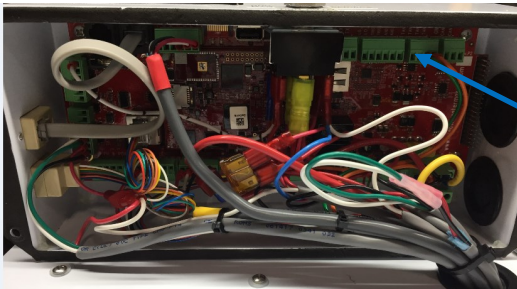

Tank Switch 1

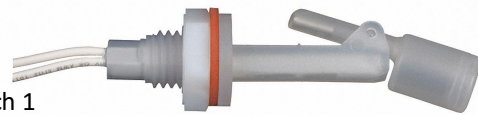

The float switch must be connected to the Tank Switch 1 terminals on the Spectra Connect control board at the Feed Pump Module. There is no polarity.

For Instructions on enabling the 'Auto Fill' mode see the System Settings instructions later in this manual.

Watermakers should never be run unattended!!

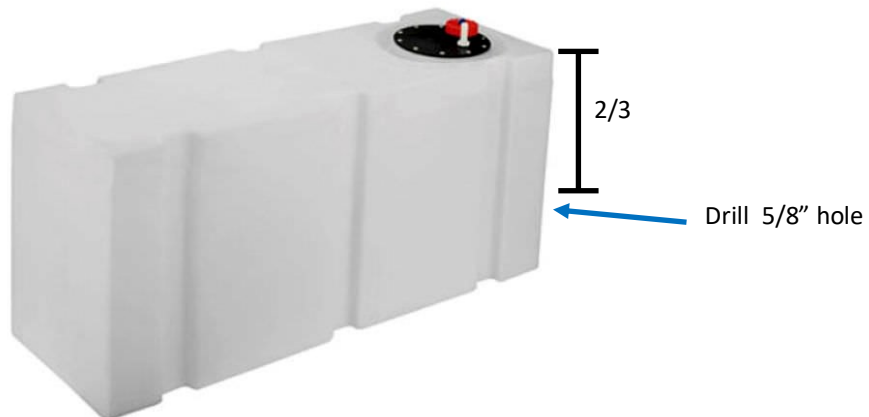

Optional Tank Level Sensor Installation

The optional Tank Level sensor allows even greater control of your ship's fresh water systems. This unique level monitoring system requires no holes to be drilled into your tank while measuring tank volume with greater accuracy than a standard resistive float.

Turn off the ship's domestic water system, close the fresh water supply valve at the water tank, then bleed off the pressure by opening a tap in the galley or head sink.

Install a tee in the **water supply hose at the bottom of the tank, or at inlet to the domestic water pump**. Connect open leg of the tee to the Tank Level Sensor. Note: The tank level sensor requires a 1/4" npt connection. We recommend installing a minimum 1/2" tee, and using a reducing bushing to connect the sensor.



Route the 3 conductor cable back to the Spectra Connect control board at the feed pump module. Extend the wires as necessary. *If you must extend the wires beyond 50' contact the factory to ensure proper operation.*

Connect the Tank Level Sensor cables to the 3 conductors label Tank Level Sensors at the feed pump module. **Polarity must be maintained!**

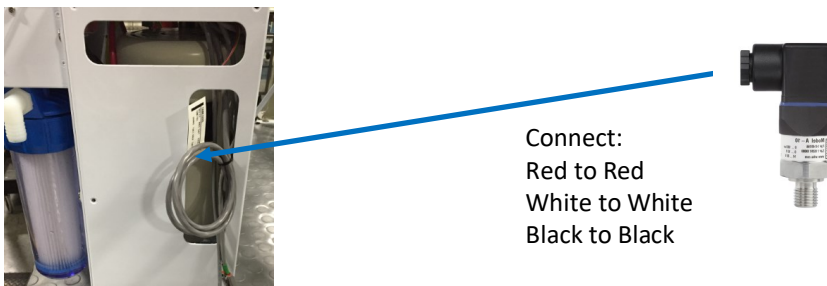

Connect:
Red to Red
White to White
Black to Black

If a 2nd Tank Level Sensor is going to be installed, it should be installed at the base of the second tank. **If monitoring 2 water tanks, they must be isolated from each other with a valve to read properly.**

The wiring connections for the second Tank Level Sensor are located inside the Spectra Connect control box. **See System Settings section of this manual for instructions on enabling the second Tank Level Sensor.**

See the Tank Level Calibration (pg. 28) in the Commissioning section of this manual.

Commissioning

New System Start-Up and Testing

Use this procedure when starting a new watermaker for the first time and **whenever the system contains preservative or cleaning chemicals.**

Avoid running the system if the vessel is in contaminated water, such as a dirty harbor or canal. The system should be fully run tested before leaving on an extended journey. It is preferable to sacrifice a pre-filter by testing the system briefly in turbid water rather than waiting to get offshore to discover a problem or deficiency in the installation. If the location or weather prevents proper testing refer to the section Dry Testing with an Artificial Ocean.

Warning! Damage may occur if the purge sequence is bypassed and the membrane is pressurized with storage chemical in it.

1. First Check That:

- Seacock is open
- Toggle switch on the Feed Pump Module is in the Run Auto position
- Domestic fresh water pressure system is on.



2. Open pressure relief valve 1/2 turn and remove the Green Tag and washer!

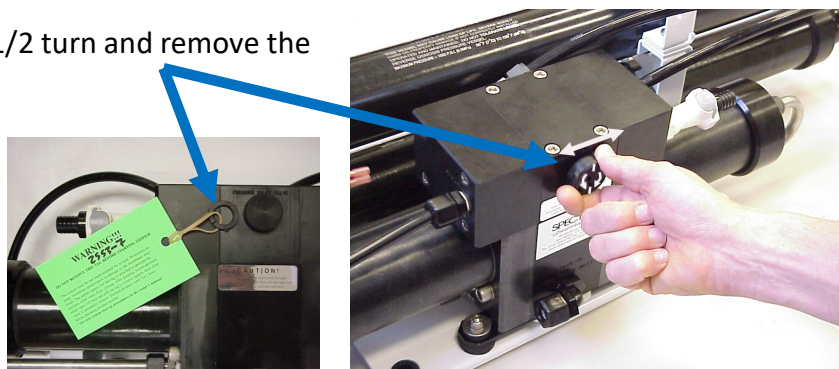

3. Turn on the power to the system and the Spectra Connect screen will display, "Has the system been stored with chemicals?" Press 'Yes', to start the Purge sequence. Note: The watermaker will shut down if the pressure relief valve is left closed during the Purge mode.

- Alarm will sound
- Display will read "Has the system been stored with chemicals?"
- Confirm the Pressure Relief Valve is open
- Press 'Yes' to start the Purge sequence

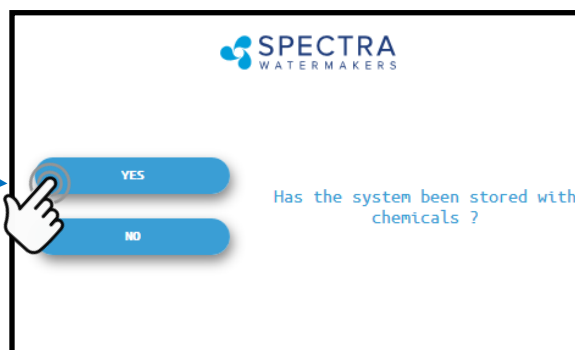

New System Start-Up and Testing continued...

- The system will start purging and the display will show the progress and time remaining

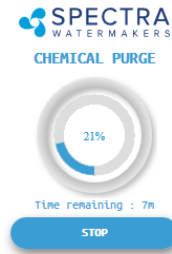

Check the strainer and the brine discharge for water flow. The system should fully prime within 60-90 seconds and all air should be out of the feed water hoses. The feed pump will sound smooth.

There should be no bubbles anywhere in the intake hoses. **If the feed pump continues to sound rough, find the reason before continuing!** Inspect the system for leaks.

Note: If you must stop the purge sequence for any reason, the control will default back to the beginning of the purge mode to protect your system.

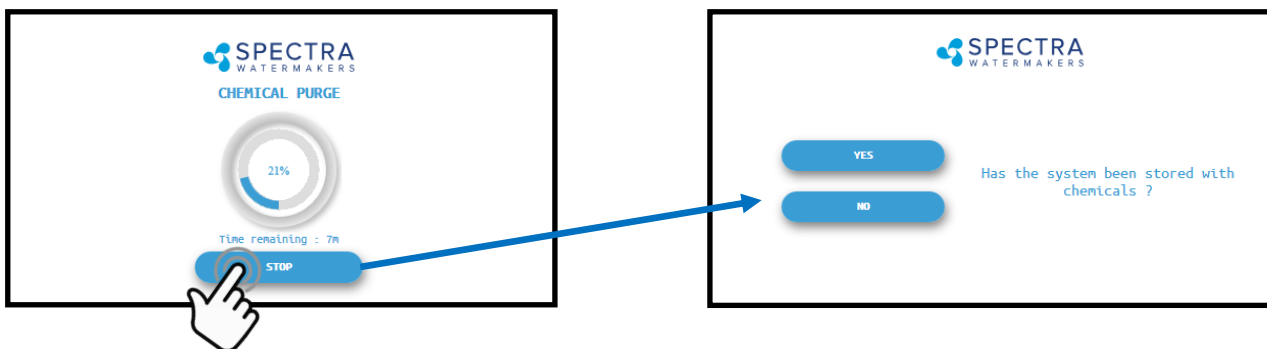

- After the purge sequence the display will alarm with the message “Close pressure relief valve.” **Close the valve** and proceed by pressing **Ok** to resume the Purge Cycle. *If the system is new from the factory, or stored with Propylene Glycol, additional purging time may be required.*

- The system will now run under pressure and desalinate water. This mode diverts the product water overboard in case there is any residual chemicals in the membrane. **Carefully inspect for leaks over the entire system!** Shut down the system and repair any leaks you find.



- After the Product Purge cycle completes, the system will prompt to **Restart**, then advance to the Main Menu. **If this is a NEW INSTALLATION, continue to the Calibration Instructions to finalize the installation.** If you are putting your watermaker back into service, your system is now ready for use.

Dry Testing with an Artificial Ocean

If it is not possible to test run the system with the boat in the water, you may test the system with an artificial ocean. You will need 1.3 lbs. of non-iodized salt (rock salt, sea salt, or aquarium salt) to make a 5 gallons (33 grams of salt per liter) of water that is about 33,000 PPM salinity (average seawater salinity). Make sure the domestic water system is powered up and the boat's tank has at least 60 gallons (230 Liters) of water to purge the storage chemicals from the system. Confirm that the charcoal filter is installed in the feed pump module, and the domestic water line is connected.

1. **Open the pressure relief valve on the Clark Pump. Remove the green tag and spacer.**
2. Power up the system. When the Spectra Connect displays “**Has the system been stored with chemicals?**”, select “**No**” to bypass the purge mode.
3. Press the **Fresh Water Flush** button to run a full flush cycle. Do this **six** times to purge the storage chemicals, a 36 minute process.
4. Replace the brine overboard hose with the brine service hose per figure 1.
5. Push the **Fresh Water Flush** button again to fill the bucket with fresh water from the brine discharge service hose (hose attached to Clark Pump). Press **Stop** when the bucket is full.
6. Mix the salt to the proper proportion or use an aquarium hydrometer to adjust the salinity level to a specific gravity of 1.025.
7. Disconnect the quick release fitting from the pigtail coming from the “To Strainer” port on the Feed Pump Module manifold and connect the intake service hose per Figures 2 and 3. Route both service hoses into a 5 gallon (20 liter) bucket. Disconnect the product tube from the manifold, and using another small piece of tube, route it into the bucket.
8. Push the **Start** button, then press **Auto Run** and program the Connect to make **10 gal (38 L)** of water, roughly 40 minutes of operation.
9. Allow the system to prime and then close the pressure relief valve. The system should build pressure shortly and start making water, with the brine and product water recombining in the bucket to be cycled again. This will gradually heat the water. Do not let the water temperature exceed 120 deg. F (49 deg. C).
10. Run the system under pressure, checking for proper operation and leaks. After testing the system, re-install the brine discharge hose, product tube, and fresh water hose from the strainer. You can now flush the system by pressing the **Fresh Water Flush** button.

Remove tag
and washer



OPEN PRESSURE
RELIEF VALVE

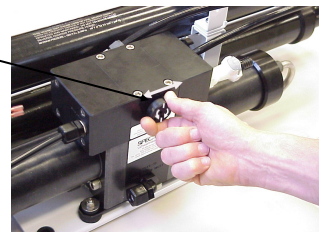

Fig. 1

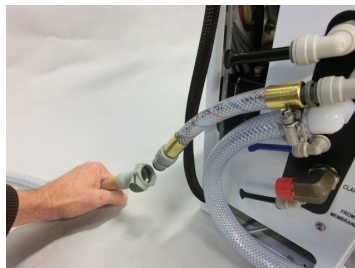

Fig. 2



Fig. 3

Sensor Calibration

Many of the settings on your system have been pre-calibrated during standard factory testing, however, there are a few settings that will vary based on the installation, vessel, and other onboard conditions. **If the system has just been installed you must calibrate the Prefilter Condition before proceeding.**

Prefilter Condition Calibration

This procedure does **not** need to be done with each filter change under normal operation, it should **ONLY BE DONE IF THE FILTER CONDITION WON'T RESET TO 100% WITH NEW FILTERS AND A CLEAN/NEW STRAINER SCREEN.**

1. During the calibration sequence the system will automatically start, begin to make water for several minutes and then shut itself down. *Make sure that the filters have been replaced for new, the strainer is clean, and all thru-hulls are open before proceeding.*
2. Follow the steps in Figures 1—4 below to initiate the Calibration Sequence.



Fig. 1

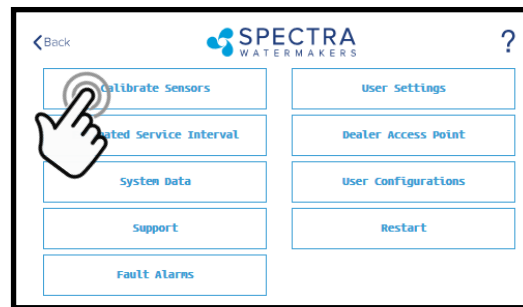

Fig. 2

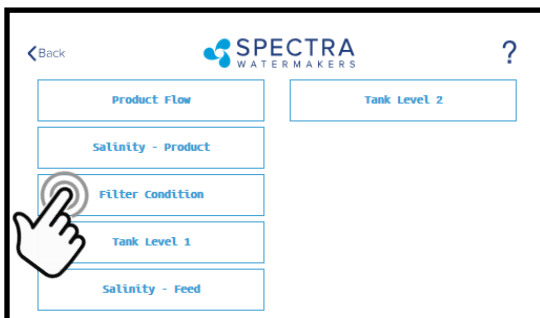

Fig. 3



Fig. 4

3. When the Calibration Sequence is complete, press the **<Back** button in the upper left corner to return to the Main Menu.
*When prompted by the display, Click **Save** to make sure that the Calibration is stored in the system memory.*



4. The Filter Condition has now been calibrated to match your installation.

Calibration continued...

Flush Adjustments

Adjustments for your Newport 400c are typically calibrated from the factory to ensure that sea water is thoroughly flushed out of the watermaker using the least amount of fresh water.

However, due to different lengths of hose runs, different rates of flow, and different pressures in shipboard fresh water systems, the flush duration should be optimized for your boat. The flush cycle is adjusted with 2 settings: the pump speed and the flush duration.

Check the pump speed

1. Close the thru-hull for the raw water inlet.
2. Push the Fresh Water Flush button. The flush valve will open and the feed pump will start at Flush Speed. If the flush completes normally, then the Flush Cycle is set properly.
3. If the display alarms 'Service Prefilters' then the fresh water pump is not supplying enough water, and the feed pump needs to be slowed down.

Slowing down the pump during a Fresh Water Flush

Under the top of the feed pump module, under the MPC box, is the pump speed controller. On the speed controller board are two magnetic reed switches for adjusting the pump motor speed. The switches are narrow black bars, 5/8" (16mm) long. The increase speed switch is labeled S2; the decrease speed switch is labeled S3. Each time a small magnet is placed near the switch with the pump is running, the speed will change slightly.

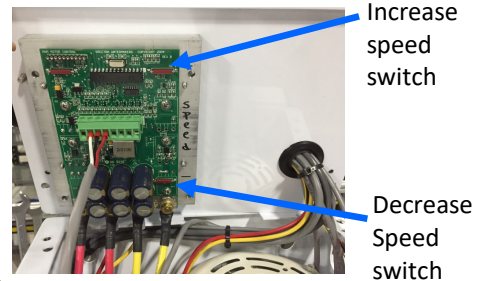

1. Open the thru-hull for the raw water inlet.
2. Push the Fresh Water Flush button.
3. Gently tap a magnet on the S3 Reed Switch (Decrease Speed Switch). Wait 3 seconds between each pass of the magnet.
4. Gently tap the magnet 3 times, then go back to step 3. Repeat this process until the Spectra Connect controller no longer alarms Service Prefilters.

Once you've adjusted the speed correctly, the speed controller will stay programmed for this speed during fresh water flushes.

Flush Adjustments continued...

3. Check/Adjust the flush duration

Run the watermaker for 10 minutes to fill the system with seawater, confirm that the diversion valve opens and water is diverted to the tanks.

Press the 'Stop' button. The system will automatically fresh water flush.

Allow the fresh water flush to continue to completion. At the end of the flush cycle capture some of the flush water at the brine discharge in a clean cup. Measure the salinity of the brine discharge and confirm that it is below 1500ppm using a calibrated hand held TDS meter.

If the flush duration needs to be increased, seek the Spectra Connect programming instructions in this manual.

Tank Level Sensor Calibration

Follow the steps in Figures 1—4 laid out below to enter the calibration sequence for the optional Tank Level Sensor(s).

1. Press the Menu Button

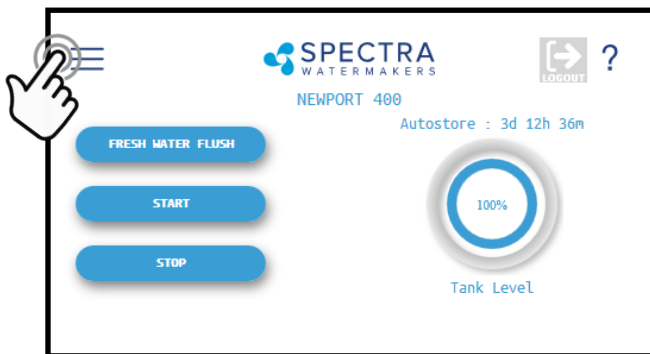

Fig. 1

2. Press the Calibrate Sensors Button

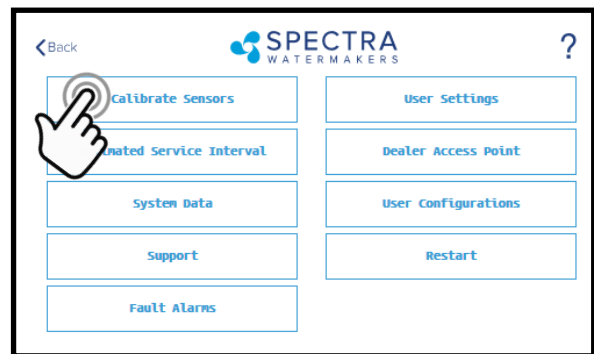

Fig. 2

3. Press the Tank Level 1 button

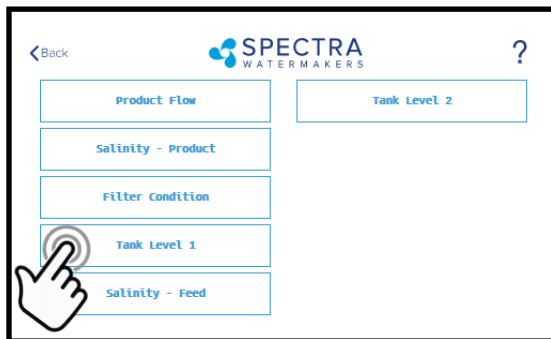

Fig. 3

4. Fill the fresh water tank to be monitored.

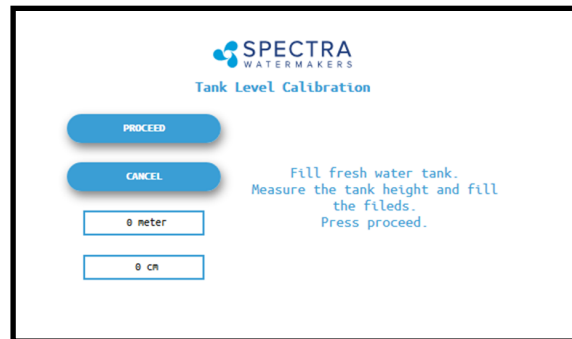
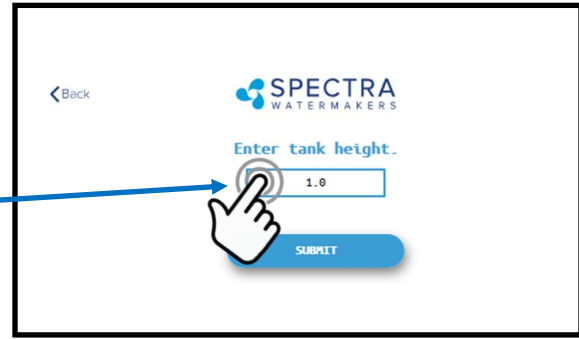
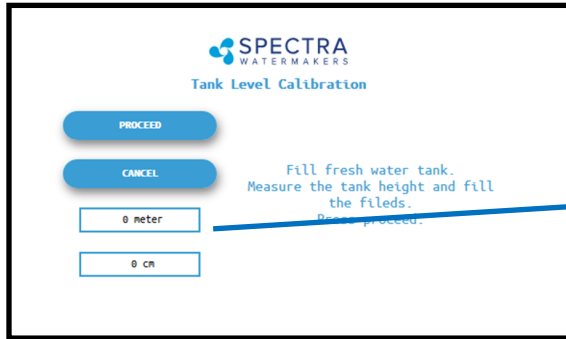

Fig. 4

Tank Level Sensor Calibration—Cont'd



5. Measure the approximate height of the water tank in feet and inches (or in meters and cm's).
6. Press the Feet (Meter) field to enter the tank height in feet (meters). Press the Inch (cm) field to enter the height in inches.

Ex: If the Tank height is 150cm:
Enter '1' in the field labeled 'Meter'
Enter '50' in the field labeled 'cm'

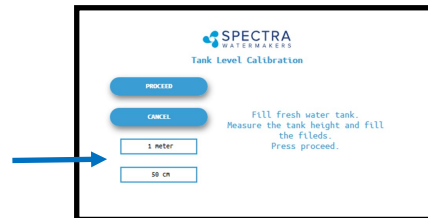

7. Press 'Submit' and confirm your entry matches your measurement.

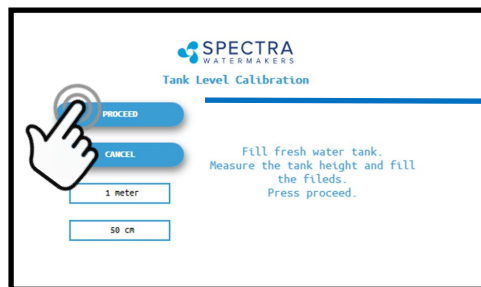

8. You must save all changes when prompted after exiting the settings menu.

Salinity Calibration

The Salinity probe has been calibrated at the factory during testing and is not normally required during commissioning. If the product quality is not reading accurately, follow calibration steps.

1. Press the Menu Button

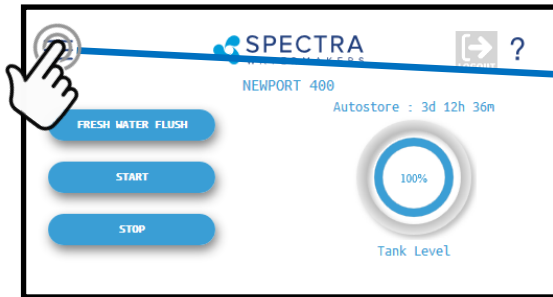

2. Press the Calibrate Sensors Button

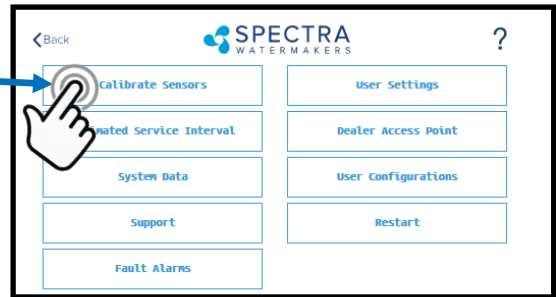

3. Press the Salinity—Product Button



Fig. 1

4. Press Continue to acknowledge the warning



Fig. 2

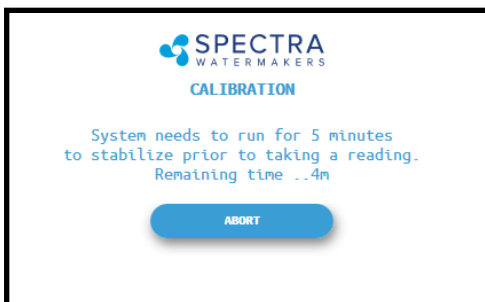

Fig. 3

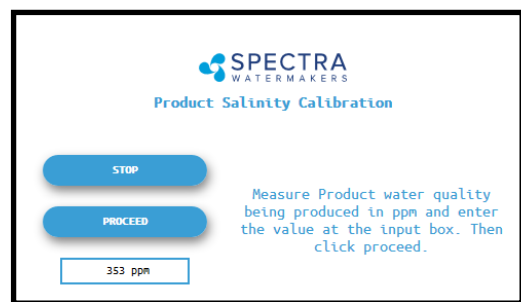

Fig. 4

5. The system will run for a minimum of 5 minutes to stabilize the product water salinity.
6. Using a calibrated handheld TDS meter measure the salinity of the product water at a sampling port, or a convenient location if no sampling valve was installed.
7. Touch the 'PPM' field and enter the reading taken above.
8. Press 'Proceed' to store the new calibration value. *You must save all changes when prompted after exiting the settings menu*

Product Flow Calibration

The Product Flow sensor has been calibrated at the factory during testing. Recalibrating is not required during commissioning. If the product flow is not reading accurately, confirm the product flow rate by following the Product Flow calibration steps.

1. Press the Menu

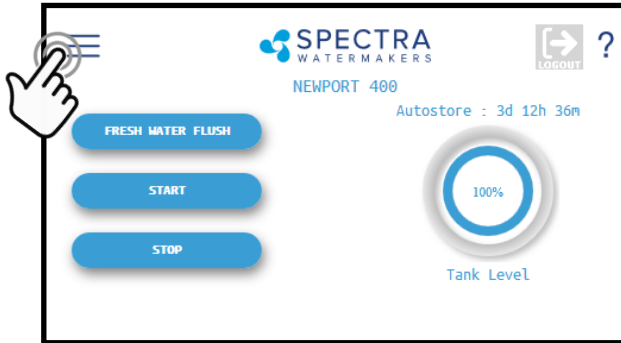

2. Press the Calibrate Sensors Button

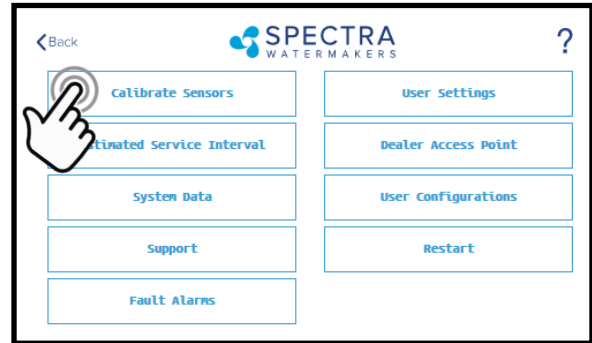

3. Press the Product Flow Button

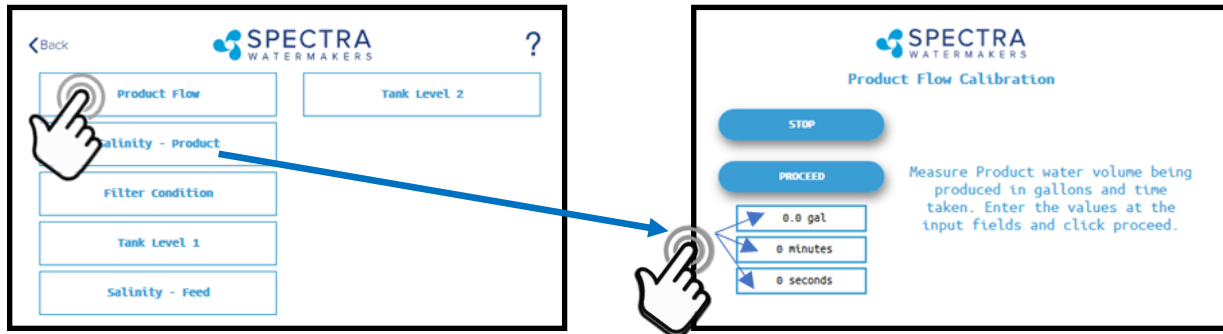

- Once the system has started and a steady stream of water is flowing from the product water tubing, time in minutes and seconds, how long it takes to fill a container of a known volume.
- Touch the 'Gal' ('Liter') field to enter the volume of the container used.
- Touch the 'Minutes' field to enter the minutes it took to fill the container. *Only enter the minutes, ex: 3 min 15 sec should be entered as 3.*
- Touch the seconds field to enter the seconds it took to fill the container. *Only enter the seconds, ex: 3 min 15 sec should be entered as 15.*
- Press 'Proceed'. *You must save all changes when prompted after exiting the settings menu*

Networking

Your Spectra Connect is equipped with state of the art networking options to allow the maximum user control in a wide variety of installations. The instructions below will help you get the most out of your Spectra Connect.

Note: Your Spectra Connect is only available when your device is connected to the same local network as the Spectra Connect control board. If you have difficulty connecting to your water-maker control application, double check that your device network is the same as your Spectra Connect

Connecting to the existing Network

1. Turn power to the system off.
2. Connect a standard Cat5e or Cat6 ethernet cable from the control board located inside the feed pump module to your ship's router or networking switch.

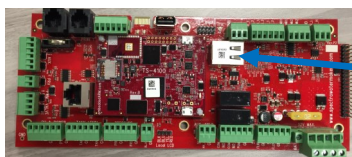

Ethernet Jack

3. Turn power to the system back on.
4. Follow the screen prompts below:

Note: If you are connecting directly into a wireless router, **DO NOT CONNECT TO THE WLAN (Wireless Local Area Network) ethernet port.** You must connect to one of the router ports labeled 1, 2, 3, 4, etc.

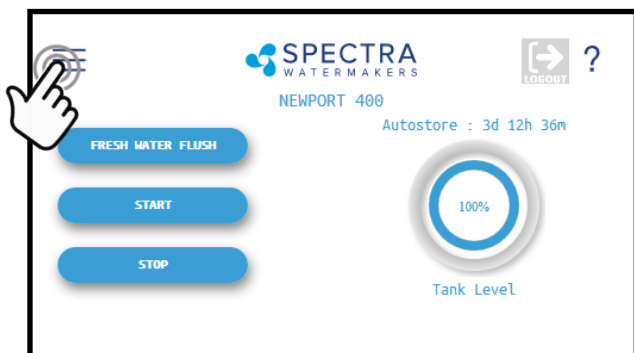

Fig. 1

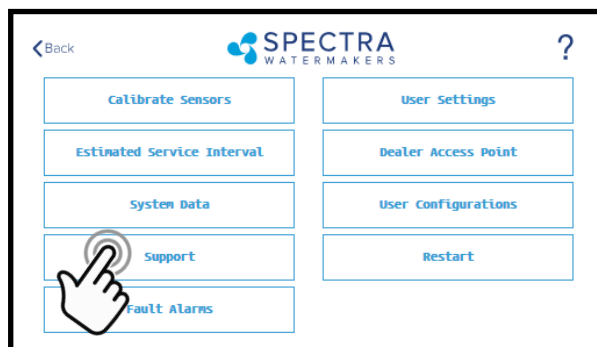

Fig. 2

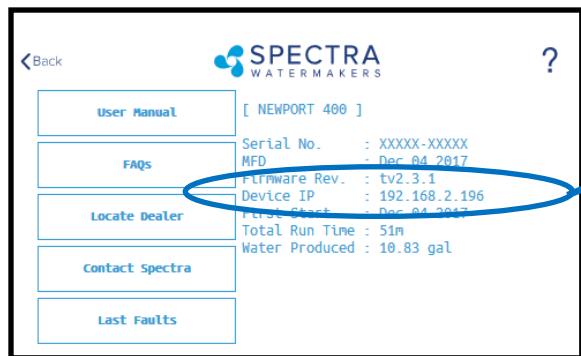

Fig. 3

Firmware Rev. : tv2.3.1
Device IP : 192.168.2.196
First Start : Dec 04 2017

5. Note the line 'Device IP' shown in Fig. 3 and record the 10 digit numerical address on the front of this manual.

Connecting to the existing Network—Cont'd

6. Connect your computer, tablet or smart phone to the local network your Spectra Connect is plugged into.

Wired Connection: simply plug your computer's ethernet port directly into the router or switch where you connected the watermaker.

Wireless Connection: make sure your device is connected to the same local wireless network as the Spectra Connect

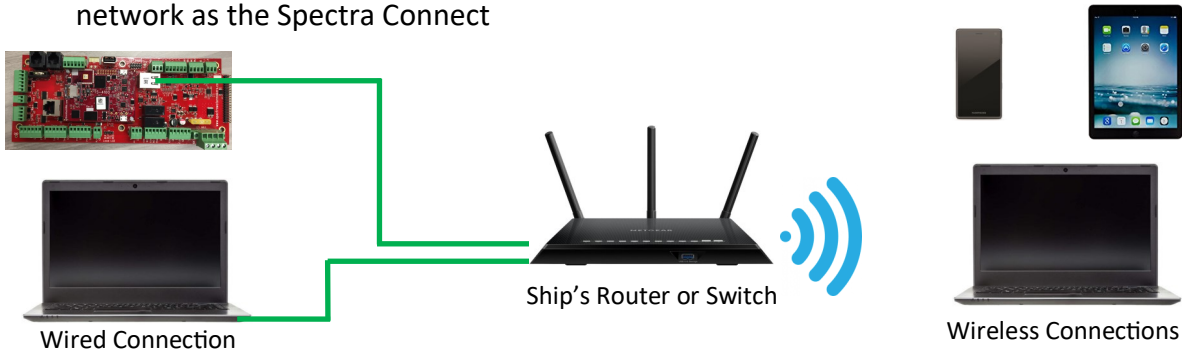

7. On the computer, tablet or smartphone, open a web browser such as Firefox, Chrome, or Safari. In the web address bar at the top, type the 'Device IP' address previously recorded. Press 'Enter'.

Note: Internet Explorer may not be compatible with your Spectra Connect web app. If formatting issues occur, use another browser such as Firefox, Safari, or Chrome.

Ex: Address Bar—Firefox

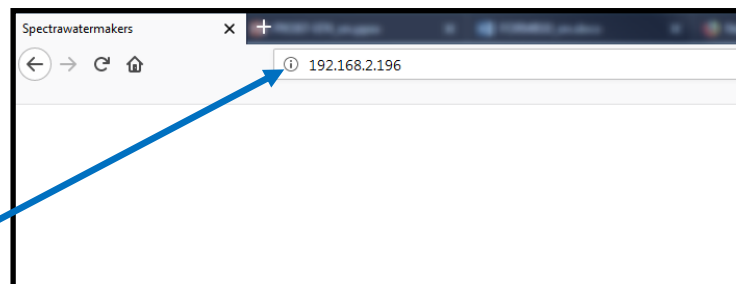

8. Your computer should now show the same image as shown on your local Spectra Connect

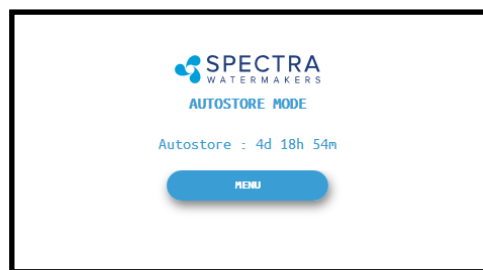

9. Your web browser is now synced with your Spectra Connect. Any buttons you press on your web browser will be controlling your watermaker.

Caution! If operating your watermaker from a computer, phone, or tablet, you must keep the tab open while the system is in operation and the volume turned up on your device in order to hear any audible alarm faults.

Normal Operation

If the system has been pickled or stored with chemicals, use the New System Startup procedure on page 23.

Your watermaker will fresh water flush **after every use**. Remember that you need to run the system approximately half an hour to make enough fresh water for one flush.

You may notice that the system output is higher when charging your batteries. This is normal.

1. Check to see that the inlet and brine discharge seacocks are open and the domestic pressurized water system is turned on.
2. Press the 'Start' button, then select the desired operating mode.

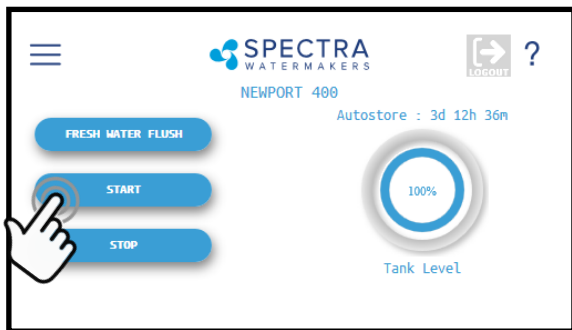

Standard Operating Modes



Runs your watermaker until the Tank Full switch closes, fresh water flushes the system, then goes into 'Auto Store' mode and the Flush Interval timer starts. *This is the default mode of operation.*



Gives you the option to run for a preset amount of time, or a preset volume of water to be produced. **If no tank switches are installed, and they have been disabled in the system settings, this is the only Operating Mode available.**

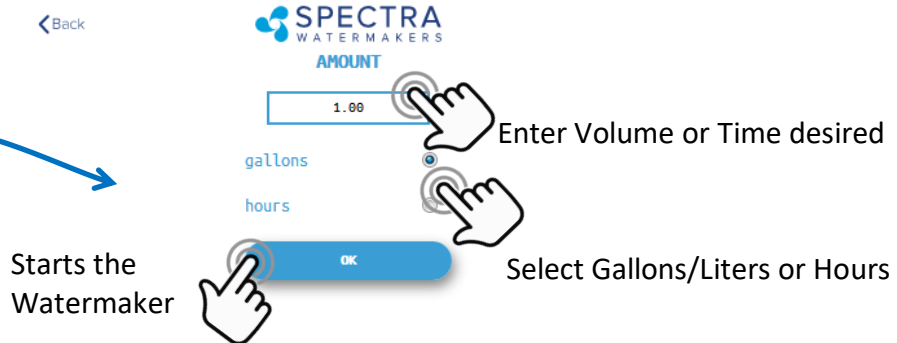

Starts the Watermaker

Enter Volume or Time desired

Select Gallons/Liters or Hours

Normal Operation—Cont'd

3. The system will now begin the start sequence. Pressing 'Stop' will bring you back to the Main Menu.



4. Once the Boost Pressure reaches the minimum threshold, the system starts operating and you will be taken directly to the Main Dashboard.

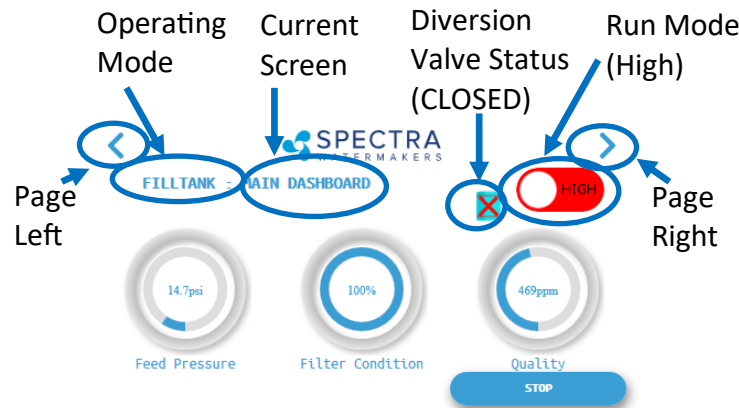

6. When the Product Water Quality is below the programmed threshold, the Diversion Valve opens, allowing water to enter the tanks and the screen image changes.

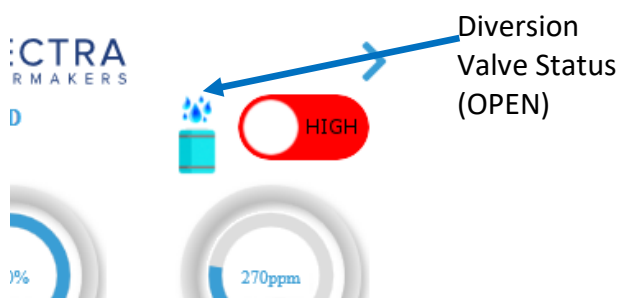

Verify that the system is operating according to the factory specifications detailed on p.36. See the Troubleshooting section to identify any anomalies.

7. Pressing the < (Page Left) or > (Page Right) arrows will show a different screen with different operating information for your watermaker.

Normal Operation—Cont'd

8. When the Run Cycle completes, or by pressing 'Stop', the system will start to Fresh Water Flush. **You MUST FRESH WATER FLUSH the watermaker AFTER EACH USE, or serious damage can occur**



8. After Fresh Water Flushing the system will enter the 'Auto Store' mode, and the interval timer until the next scheduled flush will show on the screen.

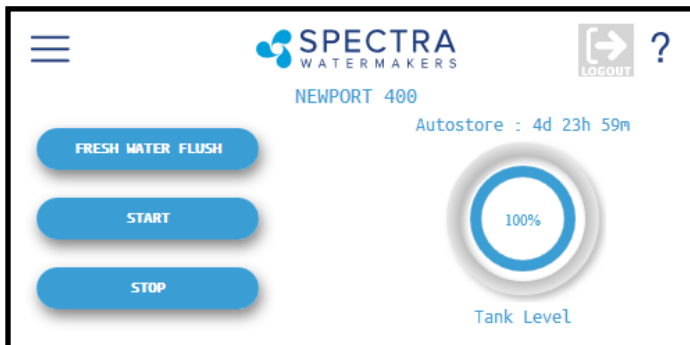

Nominal Operating Parameters

To access this information about your watermaker while it is running press the < or > buttons to scroll through the pages.

Parameter	Minimum	Maximum
Product Quantity	15 GPH (56 LPH)	17 GPH (64 LPH)
Product Quality	N/A	750 ppm
Feed Pressure	N/A	120 psi (8.3 Bar)
Boost Pressure	15 psi (1.1 Bar) or Greater	
Filter Condition	100%	
Amp Draw	25A @ 12.5vdc; 13A @ 25vdc	

Normal Operation—Cont'd

Other Operating Modes

Run Low Mode

You can toggle back and forth between Run High Mode and Run Low Mode by tapping the 'High' toggle button.

Run Low Mode may be selected to reduce power consumption or to lower the feed pressure.

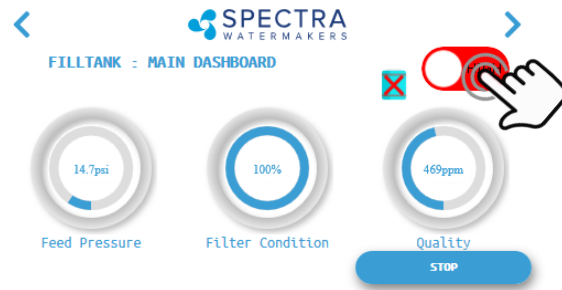

Note: The system will automatically drop to Low Mode when it senses high feed pressure, or dirty pre-filters.

Auto Fill Mode

If your vessel is equipped with a Tank Low and a Tank Full switch, **and both are enabled in the system settings**, then your Start Menu will allow the system to be operated in Auto Fill mode.



WARNING: NEVER RUN YOUR WATERMAKER UNATTENDED. EQUIPMENT CAN BE SERIOUSLY DAMAGED, AND IT IS POSSIBLE TO SINK THE VESSEL!! Use extreme caution when operating in Auto Fill mode!

In Auto Fill Mode the Spectra Connect will automatically fill your water tank, stop itself, fresh water flush, return to Auto Store mode with the flush interval timer running, and then turn itself on again to fill the tank as soon as the water level drops below the Tank Low Switch with no additional user commands.

Additionally, if power is interrupted at any stage of operation, the Spectra Connect will return to Auto Fill mode, ensuring that your tanks will always have water.

Normal Operation—Cont'd

Auto Store

Warning! Proper understanding of the Spectra flush system and the vessel's fresh water system is mandatory for extended use of Auto Store. **The flush cycles must not be allowed to drain all the fresh water from the tank or damage to the vessel's systems and the watermaker may occur.**

The Auto Store function flushes the watermaker at programmed intervals. As long as the watermaker is flushed with fresh water every 5 days (30 days with the Z-Ion) you need not store the system with chemicals.

- **Make sure there is enough water in the fresh water tanks to supply the watermaker for more than the expected time of operation in the Auto Store mode.** If there isn't enough fresh water in your tank, seawater will be drawn in and the system will not be flushed with fresh water. The Newport 400c requires about 7 gallons (26 liters) for each flush. **The boat's pressure water supply must be on and stay on** while the system is in Auto Store mode. *If these conditions cannot be met, then pickling with SC-1 storage chemical or propylene glycol is preferable.*
- Make sure the pressure relief valve on the Clark Pump is closed.
- **The system must be continually powered on during the Auto Store mode.** Turning off the power will disable the automatic fresh water flush and damage may occur.

Flushes the system with fresh water, then activates the flush interval timer:

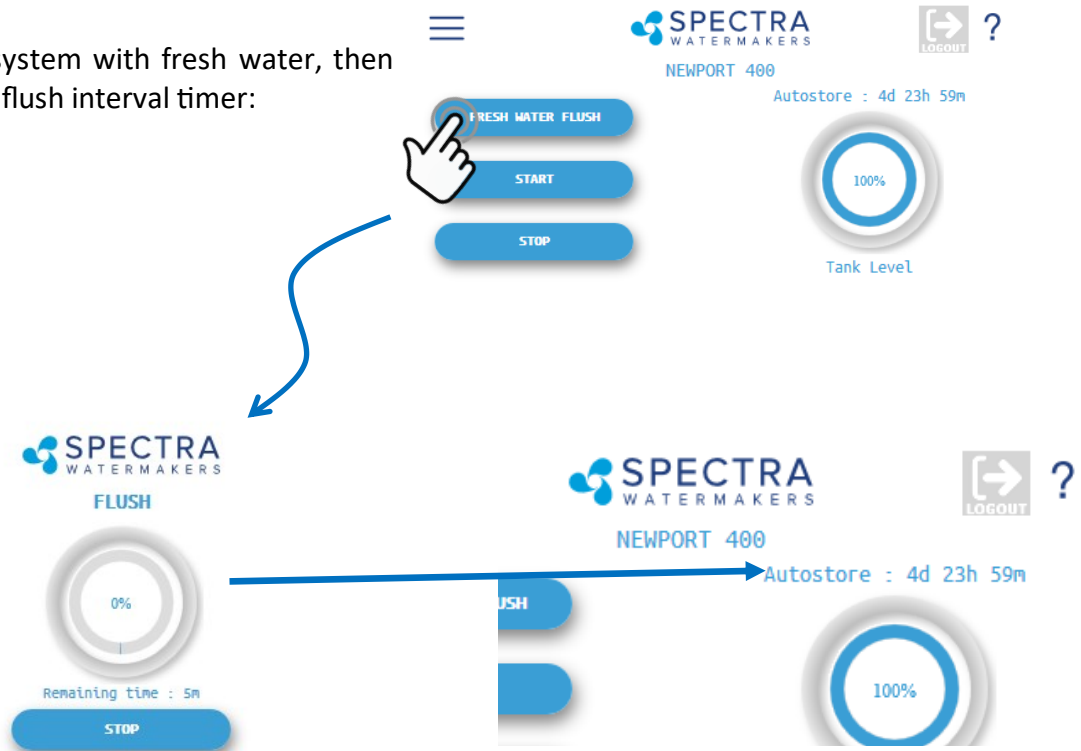

Maintenance

General

Periodically inspect the entire system for leakage and chafing. Repair any leaks as soon as you find them. Some crystal formation around the Clark Pump blocks is normal. Wipe down any salt encrusted areas with a damp cloth.

Watermakers are at their best when run regularly. Biological fouling in the membrane is more likely when a watermaker sits idle. A warm environment will cause more growth than a cold environment. A fresh water flush every five days (30 days with the Z-Ion) will greatly reduce biological growth, but may not stop it completely. The Z-Ion system protects the membrane from bio-fouling without the use of storage chemicals.

The Seawater Strainer

The seawater strainer's stainless steel element should be inspected, removed, and cleaned as needed. Ensure that the thru-hull is closed before disassembly and the gasket is in place before reassembly. When the system is put into storage, remove the strainer, rinse with fresh water, and reassemble dry to impede corrosion. Check frequently during operation.

The Pre-filters

Service the pre-filters as soon as possible after the pre-filter condition graph begins to rise. If the filter condition graph gets all the way to "Replace" the machine will slow down. When display reaches "Replace" a second time, the alarm will sound and the system will shut down to prevent damage.

To service the filters close the thru-hull, open the housings, remove the old filters, clean out the housing bowls, and reassemble the housings with new 20 and 5 micron filter elements. The 5 micron filter goes downstream from the 20 micron. Leave dry until next startup.

Use only Spectra-approved filters or you may void your warranty. Occasionally, lightly lubricate the O-rings with silicone grease.

Oil/Water Separator (Optional)

To install oil water separator capability, add a second filter housing UPSTREAM of the 20 and 5 micron housings. Service as you would per the instructions above.

The Charcoal Fresh Water Flush Filter

Replace the charcoal filter element at least every 6 months. This filter protects the membrane by removing chlorine from the flush water. Use only a Spectra-approved replacement.

Maintenance Cont'd

Leaking Fittings

The system has eight high pressure fittings, two on each cylinder on the Clark Pump, two on the pressure vessel end caps, and two 90-degree elbows on the back of the Clark Pump. As the compression fitting is tightened, it compresses a ferrule onto the stainless tubing, fixing the ferrule permanently to the tube and holding the compression nut captive.

The body of the fitting seals to the underlying component with an O-ring. On the Clark Pump cylinders and the end caps this O-ring is compressed by tightening the entire fitting. The O-rings on the 90-degree fittings on the back of the Clark Pump have captive nuts and washers, which compress the O-rings without turning the entire fitting.

If a tube fitting leaks it can sometimes be resealed by just tightening. You must use two wrenches, a 13/16-inch wrench to hold the base, and a 7/8-inch wrench to turn the compression nut. The 13/16-inch wrench will need to be thin so as not to interfere with the compression nut. If this doesn't work, disassemble the fitting, grease liberally with silicone grease (the ferrule and the threads) and re-tighten firmly.

The base O-rings should be **gently** compressed to achieve a good seal, and may be damaged by overtightening.

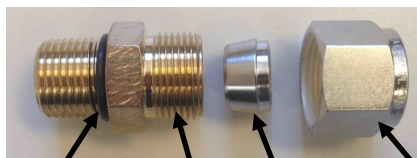

Connector O-RING

Ferrule

Stainless Fitting Hex Nut

Nickel-Bronze High Pressure Straight Fitting



Nickel-Bronze High Pressure Elbow

Maintenance Cont'd

The Feed Pump and Clark Pump

The feed pump and the Clark Pump require no routine maintenance except inspection for leaks. Tighten any hose clamps or fittings that show signs of leakage. The high pressure fittings threaded into the Clark Pump have O-ring seals with a straight thread. These should never leak and should never be over-tightened. If one of the tube nuts starts to leak, it can be unthreaded, sealed with a bit of silicone grease or oil, and tightened with two wrenches very tightly.

The Membrane

Membranes are susceptible to mineral scaling, biofouling and oxidation damage. The leading cause of fouling is biological growth that forms when the system is left unused without flushing or pickling. Fouling from mineral scaling can happen under certain seawater conditions, or from rust. Oxidation damage can occur if the membrane comes into contact with any strong oxidant, such as Ozone, Chlorine, etc. Monitor the product salinity and feed pressure for higher than normal readings, take environmental conditions into consideration.

Note that:

- Cold feed water or a higher salinity seawater source can cause high pressure.
- Low product flow is usually due to low voltage, a worn feed pump, or worn Clark Pump.

Due to the unique design of your Spectra system, low product water volume is typically not a membrane problem, but frequently related to low voltage, a worn feed pump head, or a worn Clark Pump. Always perform a flow test before cleaning your membrane.

Test to see if biological growth has occurred: Before running the system, remove the pre-filters and examine their condition. If the filter housings are full of smelly, discolored water, the system was not properly stored. Install clean pre-filters.

Next check the membrane. Detach the brine discharge hose, attach the brine service hose, and lead it to a bucket. Open the pressure relief valve 1/2 turn, and manually run the system for 30 seconds (metal toggle switch on feed pump module). Examine the brine water: If it is discolored and smells bad, perform an SC-2 cleaning with unchlorinated water before running the system pressurized. If the brine is fairly clean, follow the New System Startup procedure on page 24 and run normally. Check for performance. Clean the membranes **only if** performance is reduced.

See the **Cleaning Procedure** for complete instructions.

Maintenance Cont'd

Introduction to Spectra Chemicals

We use four types of chemicals: SC-1, SC-2, SC-3, and propylene glycol antifreeze. SC-1 and propylene glycol are for system storage, while SC-2 and SC-3 are for membrane cleaning. **Do not use sodium-bisulfate, citric acid, or any other storage chemical not supplied by Spectra.** These chemicals, used to store other watermaker brands, will damage the Clark Pump, membrane end plugs, manifolds, and other components. **Using non-Spectra chemicals will void the warranty.**

Note: Never use any chemicals with the system pressurized! Always open the pressure relief valve 1/2 turn. Always follow the instructions for purging the chemicals as shown in the New System Startup section (page 39) of your owner's manual.

Storage

SC-1 prevents biological growth when your system is idle. It should not be used as a cleaning chemical, nor will it protect your system from freezing. A jar of SC-1 is mixed with 1 to 2 gallons of product or dechlorinated fresh water in a bucket and circulated through the system for 10 minutes. This treatment will protect the system for six months, after which the SC-1 treatment must be repeated. To use SC-1, follow the instructions for **Storage Procedure**.

Spectra systems should be stored with propylene glycol if freezing is likely to occur. Propylene glycol can be used instead of Spectra SC-1 storage chemical for storage in any climate, and treatment is effective for one year. Propylene glycol is a food-grade antifreeze used to winterize RV's, boats, and cabins. Do not use ethylene glycol automotive antifreeze, which is toxic and will damage the system.

The propylene glycol formulations sold in marine and RV stores are usually diluted with water. The water remaining in the watermaker before the storage procedure will further dilute the antifreeze, reducing the microbial protection and increasing the temperature at which the mixture will freeze.

Antifreeze labeled "Minus Fifty" is a 25% solution and will begin to form an icy slush at about +15Degrees F (-10C) and will only provide burst protection to about Zero F (-18C). After a further 50% percent dilution by water remaining in the watermaker, "Minus Fifty" antifreeze will only protect from bursting down to about +25F (-4C). Therefore if low temperature freezing protection is required a 60% or stronger antifreeze should be used. 60% solutions are labeled "Minus 100" and will provide burst protection to -15F (-27C) even after a fifty percent dilution with residual water. "Minus 200" formulations are pure propylene glycol.

Maintenance Cont'd

Introduction to Spectra Chemicals—Cont'd

Complete microbial protection requires a 25% solution of propylene glycol, so care must be taken that the solution remaining in the watermaker during long term storage is at least 25%, even if freeze protection is not required. For these reasons Spectra recommends that all pickling be carried out with a 60% or greater concentration.

See **Winterizing with Propylene Glycol**.

Propylene glycol can be difficult to flush from a membrane, especially after extended storage periods. This results in high salinity water (high PPM) and residual flavor in the product water. We recommend flushing the system WITH THE PRESSURE RELIEF VALVE OPEN for 4-6 hours after storage with propylene glycol—the longer the better. If, after extended flushing, you still experience low product water quality, cleaning with SC-2 usually removes all traces of propylene glycol and returns the salinity to the level it was before storage with propylene glycol. See the **Membrane Cleaning Procedure**.

Cleaners

Avoid unnecessary cleaning, and avoid cleaning as a diagnostic tool.

SC-2 is an alkaline cleaner used to remove light oil, grime and biological growth. It is most effective if heated to 120 deg. F (49 deg. C). In most cases the water quality will increase in PPM (salinity) after an SC-2 cleaning. After a few hours it should recover to near the level it produced before the cleaning.

SC-3 is an acid cleaner used to remove mineral and scale deposits. In most cases this is used first and if there is no improvement, go on to the SC-2 cleaning. SC-3 will in most cases lower the product PPM and overall pressures. Scaling is a slow process that may take several months or years.

For cleaning with either SC-2 or SC-3, see **Membrane Cleaning Procedure**.

Storage Procedure

1. Close the intake seacock.
2. Push the **Fresh Water Flush** button to fresh water flush the system. Perform a second fresh water flush in the same way.
3. Remove the quick disconnect fitting from the brine discharge outlet of the Clark Pump, per photo below, and replace it with the quick disconnect brine discharge service hose. Lead the brine service hose into the bucket.
4. Push the **Auto Store** button and run the feed pump until you have one gallon of fresh water in the bucket from the brine discharge service hose, then press **Stop**.
5. Mix 1 container of SC-1 storage compound with the water in the bucket.
6. Remove the hose from the “to strainer” pigtail on the feed pump module and install the inlet service hose from the service kit, per photos below. Lead this hose into the 5 gallon (20 liter) bucket as well.
7. **Make sure the pressure relief valve on the Clark Pump is OPEN (un-pressurized) by turning 1/2 turn counterclockwise**
8. Turn on the feed pump by moving the manual control switch on the control box to ‘SERVICE’. The solution will be drawn from the bucket with the service hose, and returned to the bucket from the brine discharge service hose. Circulate the storage chemical in the system for approximately 20 minutes. Stop the feed pump by moving the switch back to the ‘RUN AUTO’ position.

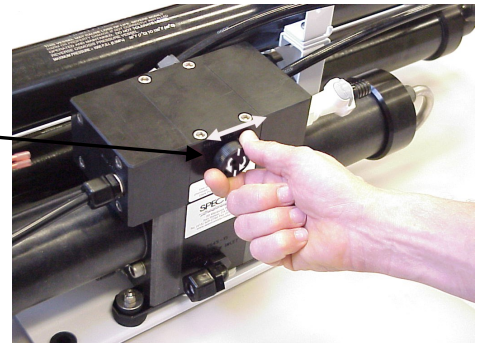

Clean Up

Remove the brine discharge service hose from the Clark Pump, and replace the brine discharge hose that leads to the thru-hull. You may now pump the bucket dry by moving the manual control switch on the Control Box back to ‘SERVICE’. Stop the feed pump by moving the switch back to RUN AUTO.

Remove the inlet service hose and reattach the hose from the sea strainer to the “To Strainer” pigtail on the manifold at the Feed Pump Module. Drain and clean the strainer and any filters in the system. Reassemble dry. Leave the pressure relief valve open, since the next time you run the system you will need to purge the storage chemicals with the system unpressurized. Turn off the power to the system.



Connecting brine discharge service hose

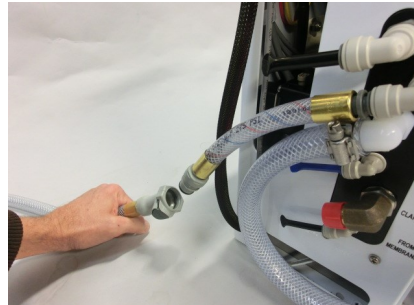

Removing hose to sea strainer from the “to strainer” pigtail.



Attaching intake service hose to the hose connecting to the sea strainer.

Winterizing with Propylene Glycol

See description of propylene glycol formulations, and purging from system, on pages 52-53.

1. Close the intake seacock.
2. Push the **Fresh Water Flush** button to fresh water flush the system. Perform a second fresh water flush in the same way.
3. Remove the hose from the “To Strainer” pigtail, install the inlet service hose from the service kit, and lead the hose to the bottom of a bucket. Connect the brine service hose, and run it into a second container.
4. Pour 1 gallon (4 liters) of propylene glycol of appropriate concentration (see pages 42-43) into the bucket with the intake service hose.
5. **Make sure the pressure relief valve on the Clark Pump is OPEN 1/2 turn (un-pressurized).**
6. Run the feed pump by switching the manual switch on the control box to ‘SERVICE’ until about a gallon of water has flowed from the brine discharge service hose, or antifreeze appears. Propylene glycol will look slightly different, and feel more slippery, than water. Stop the pump by moving the switch back to ‘RUN AUTO’. Add more propylene glycol to the intake bucket if necessary.
7. Lead the brine discharge service hose into the intake bucket of propylene glycol. Move the switch back to ‘SERVICE’. The service hose will now draw propylene glycol solution from the bucket, and the brine discharge service hose will return it. Run the feed pump and circulate the propylene glycol for 20 minutes.
8. Stop the feed pump by switching the toggle switch back to ‘RUN AUTO’. Drain the seawater strainer, the hose leading to the boost pump module, and the hose between the boost pump module and the feed pump module. Disconnect the product tubing from the membrane housing and blow residual water out of the tubing. Empty the charcoal filter housing and flush water lines. Leave the pressure relief valve open, since the next time you run the system you will need to purge the system unpressurized.

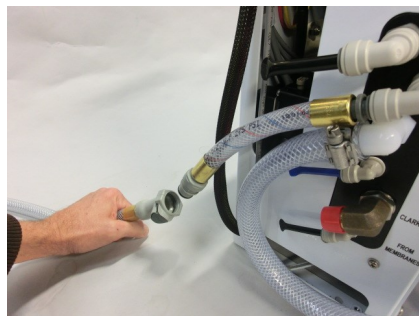
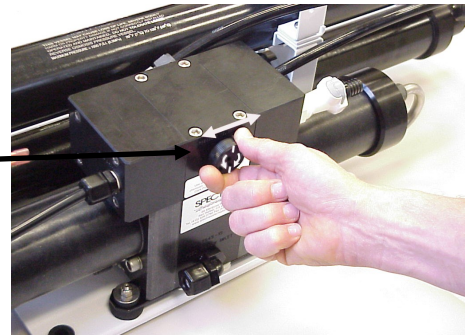

Removing hose to sea strainer from the “to strainer” pigtail.



Attaching intake service hose to hose to sea strainer.



Connecting brine discharge service hose

Membrane Cleaning Procedure

Spectra cleaning compound (SC-2 or SC-3) must be mixed with fresh water at a ratio of 1 container of compound to 3 gallons (12L) of unchlorinated water. A Newport 400c system requires one container of compound per cleaning.

1. Close the intake seacock.
2. Push the **Fresh Water Flush** button to fresh water flush the system. Perform a second fresh water flush in the same way.
3. Remove the quick disconnect fitting from the brine discharge outlet of the Clark Pump, and replace it with the quick disconnect brine discharge service hose. Lead it into a 5 gallon (20 liter) bucket. Push the **Fresh Water Flush** button and run the feed pump until one gallon of fresh water runs into the bucket from the brine discharge service hose. Press **Stop**.
4. Remove the hose from the "To Strainer" pigtail and install the inlet service hose from the service kit. Lead both hoses into the bucket.
5. **Make sure that the pressure relief valve on the Clark Pump is open (un-pressurized).**
6. Mix the cleaning chemical in the bucket. If possible, heat the solution to 120 F (49 C).
7. Move manual switch on the MPC control box to SERVICE SYSTEM. The intake service hose will draw solution from the bucket and the brine discharge service hose will return it. Circulate the solution through the system in this manner for 45 minutes. Stop the pump by moving the toggle switch back to 'RUN AUTO'.
8. If the solution cannot be heated, allow the solution to sit overnight before proceeding to the next step.
9. Replace the brine discharge overboard hose and run the pump until the bucket is empty by moving the manual switch to 'SERVICE'. Return the switch to 'RUN AUTO'.
10. Follow the New System Startup procedures to flush the chemicals out of the system (**DO NOT CLOSE the pressure relief valve!**)
11. The system may now be restarted, flushed, or stored.

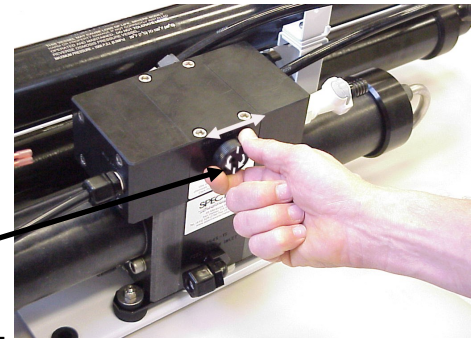

Connecting brine discharge service hose

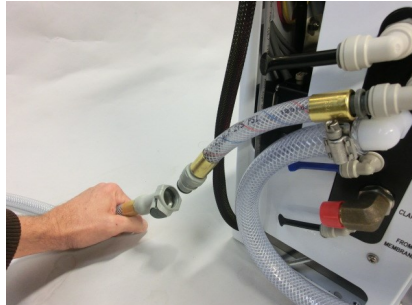

Removing hose to sea strainer from the "to strainer" pigtail.



Attaching intake service hose to the hose connecting to the sea strainer.

Suggested Spares for the Newport 400c

Short term cruising, weekends etc.

A basic cruise kit B. This kit consists of three 5 micron filters, three 20 micron filters and two packs of SC-1 storage chemical.

Cruising 2 to 6 months at a time.

Two basic cruise kits, one replacement charcoal filter, and one replacement feed pump head.

Longer than 6 months

Additional filters, offshore cruising kit consisting of Clark Pump seals, o-rings, tools and membrane cleaning chemicals. One replacement strainer screen, replacement o-ring for strainer screen, and replacement o-rings for the filter housings.

Common Parts:

Item	Part Number
SC-1 STORAGE CHEMICAL	KIT-CHEM-SC1
SC-2 CLEANER	KIT-CHEM-SC2
SC-3 CLEANER	KIT-CHEM-SC3
BASIC CRUISE KIT B	KIT-BCK-B
OFFSHORE REBUILD KIT	KIT-OFFSH
5 MICRON FILTER	FT-FTC-5
20 MICRON FILTER	FT-FTC-20
CHARCOAL FILTER	FT-FTC-CC
6" STRAINER SCREEN	FT-STN-6S
FEED PUMP HEAD	PL-PMP-140MAG
6" STRAINER O-RING	SO-STN-6SS
FILTER HOUSING O-RING	SO-FHS-3PCS10

Troubleshooting Newport 400c

SYMPTOMS	PROBABLE CAUSE	REMEDY
Feed pump runs constantly, will not turn off	<ul style="list-style-type: none"> • Toggle switch on control box to RUN MAN or SERVICE • Speed Control damaged 	<ul style="list-style-type: none"> • Turn switch on control box to RUN AUTO • Replace Speed Control
Feed pump runs with loud noise	<ul style="list-style-type: none"> • Intake blocked • Air in system • Boost pump not operating 	<ul style="list-style-type: none"> • Check thru-hull valve • Check sea strainer for leaks • Check fresh water flush module for leaks • Re-prime system (restart) • Confirm voltage at Boost Pump, check wiring connections.
No lights or display, system does not operate	<ul style="list-style-type: none"> • Display has gone to sleep • Remote display not connected • No power to control box 	<ul style="list-style-type: none"> • Touch the screen to wake it up • Check display cable connections at back of display and at control box • Check and reset main DC supply breaker • Check voltage to control box, check 20A fuse on control board. • Try manual switch on control box: If pump runs, then MPC or display may be defective
Display activates, but pump will not run	<ul style="list-style-type: none"> • Loose or broken pump wire connection • Tanks are full (if equipped with tank switch) • Speed control overheated 	<ul style="list-style-type: none"> • Check wiring at terminal block inside control box • Check tanks– system cannot be started if tanks are full. • Improve cooling
System runs, no product water delivered to water tanks, Product volume gauge good, Diversion valve shows activated on display	<ul style="list-style-type: none"> • Diversion valve inoperative or wiring fault. • Disconnected or broken product tubing • Diversion valve plunger stuck 	<ul style="list-style-type: none"> • Check wiring at diversion valve and inside control box • Check product tubing • Exercise diversion valve by pressing the manual button top, retest. • Replace diversion valve.
System runs, no product water delivered to water tanks, Product volume gauge good, Diversion valve shows deactivated on display	<ul style="list-style-type: none"> • High salinity of product water, causing system to reject water • Salinity probe out of calibration or defective, bad cable • Chlorine damage to membranes • Pressure relief valve partially open 	<ul style="list-style-type: none"> • Check for low feed pressure • Check for leaks at high pressure hoses • Test product water with hand-held tester– if over 500 PPM for 1 hour, see 'Poor Product Quality' on p.50 • Close pressure relief valve

Newport 400c Fault Alarms

SYMPTOMS	PROBABLE CAUSE	REMEDY
<p>“System Stalled” (“system stalled” may alarm when using the control panel to run system for servicing with the pressure relief valve open– use manual override switch instead)</p>	<ul style="list-style-type: none"> • Pressure relief valve open • Intake thru-hull closed • Airlocked system • No signal from Rotoflow meter 	<ul style="list-style-type: none"> • Close pressure relief valve • Check thru-hull • Purge air • Check wiring, clean or replace Rotoflow meter
<p>“High Pressure”</p>	<ul style="list-style-type: none"> • Blocked brine discharge • Fouled membrane 	<ul style="list-style-type: none"> • Check brine discharge • Clean membrane
<p>“Re-starting”</p>	<ul style="list-style-type: none"> • No signal from Rotoflow meter at startup. • System airlocked 	<ul style="list-style-type: none"> • See remedy above for “system stalled”
<p>“Service Prefilter”</p>	<ul style="list-style-type: none"> • Clogged filters • Loose or defective pressure sensor wires 	<ul style="list-style-type: none"> • Install new filters • Check sensor wiring • If the error persists, follow Prefilter Condition Calibration instructions.
<p>“Salinity High”</p>	<ul style="list-style-type: none"> • High product water salinity • Chlorine damage to membranes • Defective salinity probe or cable, cable disconnected 	<ul style="list-style-type: none"> • Check for low feed pressure • Check for leaks at high pressure hoses • Remove and clean probe contacts. Check calibration • Check cable connections • Clean membrane
<p>“Can’t Connect to Watermaker from Web Browser”</p>	<ul style="list-style-type: none"> • Device (phone/tablet/computer) not connected to same network • Router/Switch turned off • Watermaker turned off • Connecting to wrong web address 	<ul style="list-style-type: none"> • Check the wireless network on your mobile device or computer • If using a wired connection, confirm you are connected to the same network. • Make sure Router/switch has power. • Restart Router/Switch • Make sure watermaker is powered on • Confirm Device IP address matches address typed into browser

Troubleshooting Newport 400c

SYMPTOMS	PROBABLE CAUSE	REMEDY
Device IP in Support Menu reads 'NIL'	<ul style="list-style-type: none"> • Control board not connected to router or switch • Control board not receiving IP address from router or switch 	<ul style="list-style-type: none"> • Connect the control board to a router or switch according to the Networking instructions • Cycle power on the water-maker with the network cable connected
Tank Level not accurate	<ul style="list-style-type: none"> • Tank Level not calibrated • Domestic water pump running • Water tanks sloshing while underway, no baffles in tanks • Tank sensor failed 	<ul style="list-style-type: none"> • Calibrate tank level according to calibration instructions • Stop domestic water pump and check tank level • Re-check tank level accuracy while vessel in in port and sea state is calm • Replace sensor
Tank Level shows '!'	<ul style="list-style-type: none"> • Tank Level sensor disabled in Settings 	<ul style="list-style-type: none"> • Verify tank level sensor is installed, and enable the tank level sensor
Power suddenly drops out and watermaker restarts	<ul style="list-style-type: none"> • Electrical short, or failed boost pump • Electrical short, or failed solenoid valve • Electrical short, or failed pressure sensor • Electrical short, or failed speed control • Electrical short, or failed salinity probe 	<ul style="list-style-type: none"> • Disconnect boost pump wires from control board and cycle power. Check boost pump for electrical short. • Replace Boost Pump • Disconnect solenoid valves from control board and check valve for a short. • Replace valve • Disconnect speed control and cycle power. Check speed control for electrical short. • Replace Speed Control • Disconnect salinity probe wires from control board and cycle power. • Replace Salinity Probe

Alarm Override and Manual Operation

In the event of a sensor failure resulting in a shut down due to a false alarm, the failed sensor can be overridden electronically, see System Settings section in this manual. High Pressure, Service Prefilter, System Stalled (airlock), and High Salinity can all be overridden and the system will still run automatically with all other functions intact.

Be absolutely certain that the alarm is false before overriding the automatic controls.

In the event of complete Spectra Connect control failure, the system may be operated manually as follows:

- Switch on the feed pump by setting the feed pump switch to RUN MAN. The automatic safety controls are disabled in manual mode. Shut the unit down if the Clark pump does not cycle, if air is continuously present in the intake line, or if the feed pump is excessively noisy.
- Always discard the product water for the first few minutes of operation as the initial product water may not be potable. Take a water sample by loosening the 1/4-inch product tube fitting at either the feed pump module or the membrane outlet. Check it with a handheld salinity meter or taste it.
- The diversion valve is an electrically operated three-way valve, which is normally energized by the MPC controls in order to send water to the tank. It will not open automatically in manual mode, and must be opened using the mechanical override button. **The valve is located behind an access opening on the left side of the feed pump module.** Push the manual override button in and rotate 1/4 turn clockwise to open the valve.

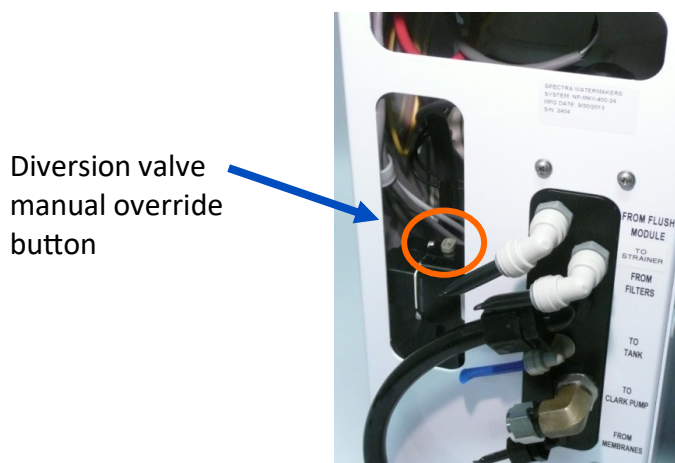

Push Diversion valve button down and turn 90 degrees to manually open valve



Newport 400c Flow Test

The flow test is the most useful diagnostic test for system performance, and should be done before replacing or cleaning your membrane. Changes in production or water quality are normally caused by something **other than** the membrane, unless the system has been left unused for a long time.

Before the flow test, change all filters and clean the sea strainer. Carefully check for water or air leaks, as air in the system will cause low production and erratic salinity. Look for air bubbles in the product flow meter, feed water hoses, and brine overboard hose.

Run the system and watch the feed pressure very closely. If the feed pressure to the Clark Pump is asymmetrical from one stroke to another, this could be part of the problem. A difference of a few PSI is acceptable, but anything over that is an issue. If the pump is asymmetrical, Clark Pump repairs should be done before continuing with these tests.

If no asymmetry is noted, continue with this test.

You will need a graduated bucket, a smaller graduated pitcher or large measuring cup, and a stopwatch. Measurements must be very accurate, as errors of just a few percent will skew the results. Log the voltage at the feed pump at the same time. Confirm at least 12.5 volts at the pump on 12-volt systems; 25 volts on 24-volt systems. You may have to run the engine or battery charger during the test.

Take two measurements and compare them with the table on the next page. The first measurement is the product flow alone. The second is the product flow combined with the brine discharge flow to get the total flow or feed flow. You may take these measurements by two methods:

1. First time the product flow into a graduated pitcher, then divert both the product flow and brine discharge together into a bucket to measure total flow.

OR

2. Divert the product flow into the pitcher while diverting the brine discharge into the bucket. Time the flow of both. After calculating the product flow, pour the pitcher of product into the bucket of brine to measure total flow.

The ratio of product flow to total flow gives us our recovery rate, as a percentage. If the percentage is below the minimum it indicates an internal leak in the Clark Pump.

1. Product Flow: Product flow is expressed in Gallons Per Hour (GPH) or Liters Per Hour (LPH), by this equation:

$3600 \div \text{time in seconds} \times \text{quantity of water in gallons or liters} = \text{GPH or LPH}$
 There are 3600 seconds in an hour.

Example: It took 3 minutes and 35 seconds to collect 1 gallon of product water.
 $3600 \div 215 \times 1 = \mathbf{16.74 \text{ GPH}}$ (3 minutes, 35 seconds is 215 seconds)

Example: It took 2 minutes and 25 seconds to collect 2.5 liters of product water.
 $3600 \div 145 \times 2.5 = \mathbf{62.07 \text{ LPH}}$ (2 minutes, 25 seconds is 145 seconds)

2. Total Flow or Feed Flow: Feed flow or total flow (brine + product) is expressed in Gallons Per Minute (GPM) or Liters Per Minute (LPM), by this equation:

$60 \div \text{time in seconds} \times \text{quantity of water in gallons or liters} = \text{GPM or LPM}$

Example: It took 1 minute and thirty-seven seconds to collect 5 gallons of total flow.
 $60 \div 97 \times 5 = \mathbf{3.09 \text{ GPM}}$ (1 minute, 37 seconds is 97 seconds)

Example: It took 53 seconds to collect 12 liters of total flow.
 $60 \div 53 \times 12 = \mathbf{13.58 \text{ LPM}}$

3. Recovery Rate: $\text{Product Flow} \div \text{Total Flow} = \text{Recovery Rate \%}$

Example: $\frac{6.5 \text{ GPH product flow}}{1.7 \text{ GPM total flow} \times 60} = \mathbf{.063 \text{ or } 6.3\%}$

(you must first multiply total flow by 60 to convert from GPM to GPH)

System	AMPS				Feed Pressure	bar	Static * Pressure	Feed Flow				Product Flow			
	12V	MAX	24V	MAX				Flow	Flow	MIN	MIN	Flow	Flow	MIN	MIN
					PSI		PSI	GPM	LPM	GPM	LPM	GPH	LPH	GPH	LPH
NP 400 HI	≈ 24	26	≈ 12	13	90-110	6.3-7.7	25-35	2.8	10.6	2.7	10.2	17	64.3	16	60.5
NP 400 LO	≈ 16.5	18	≈ 8.5	9	80-90	5.6-6.3	25-35	2.3	8.7	2.2	8.3	12.3	46.5	11.5	43.5

*pressure relief valve open ½ turn

For every $\frac{1}{10}$ th of a GPM feed water flow loss, we will lose about $\frac{1}{2}$ gallon per hour of product flow and the salinity will go up 100 PPM.

Low feed flow combined with low system pressures is most frequently caused by a worn pump head.

Poor Product Water Quality

With any product water quality issue, you must ensure accurate calibration if you are using a salinity meter. For general quality evaluation, your taste is always good enough.

Membranes are not an exact science and two identical systems can have different product quality. World health standards deem water of up to 1000 PPM of total dissolved solids acceptable for drinking. We consider any thing below 750 PPM acceptable but not ideal, and anything below 500 PPM excellent. Factors that could affect water quality are addressed below.

LOW SYSTEM FLOW OR PRESSURE will equate to lower product quality (higher PPM).

Newport systems, which have a higher feed to output pressure ratio (See nominal pressures under Flow Test), as well as a higher feed flow/membrane area ratio, will produce water in the 150-300 PPM range.

DAMAGE TO THE MEMBRANE by chlorine contamination. Flushing the system with chlorinated water will irreparably damage the membrane. Charcoal filters are used to absorb any chlorine which might be present in flush water. They must be of proper specification to be suitable. There is no test for chlorine damage except the process of elimination of other causes.

DIRTY OR SCALED membranes. A dirty (foreign material), scaled (mineral deposits), or contaminated (bacterial growth) membrane can result in poor water quality and abnormal operating pressures. If operating pressures are above normal, then cleaning is indicated. If the system pressures are within operating normal range, cleaning may have little result. Avoid cleaning as a diagnostic tool. Low water quality after storage with propylene glycol can usually be remedied by extended flushing or an SC-2 cleaning.

MECHANICAL LEAKAGE within the membrane pressure vessel. This is an unlikely but possible cause of poor water quality. A pinched or damaged O-ring within the pressure vessel, a scratch on the product tube on the membrane, a scratch within one of the end caps, or a seal fouled by contamination could allow sea water into the product water.

If system flow (product plus brine) is 2.7 GPM (10.2 LPM) or above, the membrane is clean, the product flows are consistent with the system flow and the water quality is still not acceptable, then replacement of the membrane is indicated.

Technical Bulletins

The following pages include Spectra's most commonly-used technical bulletins, covering tests, adjustments, troubleshooting, and common points of confusion. Many more technical bulletins are available on the Spectra website, www.spectrawatermakers.com.

ACCUMULATOR PRESSURE

Your Newport 400c is supplied with a pressure accumulator tank (PL-ACC-TK) installed in the feed water line on the feed pump and the Clark Pump.

The purpose of the feed line accumulators is to reduce the spikes in the feed pressure caused by the cycling of the Clark Pump. If the accumulators are not properly charged it can lead to pressure spikes and system shut down. The accumulator has a Schrader air valve, like a car tire, which allows the internal air bladder of the accumulator to be pre-charged. The accumulator should be pumped up to about 60 PSI (4.1 bar) for best results. Add air using a tire pump or air compressor. You can experiment with the exact pressure that will give the best pulsation dampening on your installation.

Schrader valve



PREFILTERS

During normal operation, the feed water is filtered in two stages. First it passes through a fine mesh metal sea strainer, which protects the boost pump from foreign materials and sea creatures. After passing through the boost pump, the feed water passes the filter housings containing the 20 and 5 micron elements, removing very fine particles that could damage the feed pump or Clark Pump and shorten membrane life. An additional carbon filter prevents the entrance of chlorine during fresh water flushing (see next page).

Pre-filter maintenance schedules will vary widely depending on how and where the system is used. If large amounts of feed water are run through the system in biologically fertile near-shore waters the pre-filter will plug up, water production and quality will drop, and the system pressure will change dramatically. In blue water conditions the pre-filter may only need to be changed every week or two.

When operated for only an hour or two a day in inland or near-shore waters, the trapped organisms will begin to decay in the filters long before the elements plug up. These decaying organisms will cause a rotten egg smell in the product water. This decay will set in overnight in tropical waters, or after a week or two in higher latitudes. Fresh water flushing will greatly reduce this biofouling process, and must be done after every use and at least once per week during periods of nonoperation.

If filters become plugged or biologically fouled, they must be replaced. Our filter element part numbers are FT-FTC-5 for a 5 micron element, FT-FTC-20 for a 20 micron element. The optional oil/water separator is FT-FTC-OW.

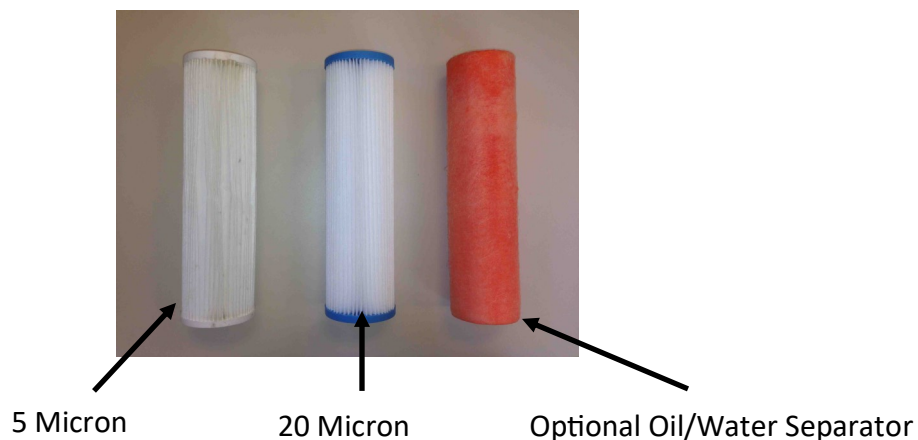

CHARCOAL FILTERS

The charcoal filter element (FT-FTC-CC) removes chlorine from the fresh water flush water supply, as the RO membrane can only handle small amounts of chlorine without permanent damage.

The charcoal filter used for the fresh water flush system will not plug up unless you have very dirty domestic water in your boat's supply tank.

The charcoal filter we supply removes 99.7% of the chlorine. Beware when buying other charcoal filters. If they don't specify the percentage of chlorine removed, don't use them. Cheap ones may remove only 60% or 70%. Also, there are aftermarket filters which are very close to, but not exactly the right dimensions, and they will not seal in the housing. If you skimp on the charcoal filter you risk damaging a \$600.00 membrane on the first flush. The other factor is the flow rate that the filter can handle. Because the chlorine is adsorbed by the charcoal, it must remain in contact with the charcoal for a sufficient period of time for the all of the chlorine molecules to be captured. The filters we use can handle 1.5 gallons (6 liters) per minute flow, and are good for 3000 gallons (12,000 liters) at 1.5 GPM, or six months, whichever comes first. Regardless of the amount of water treated, the charcoal loses its effectiveness after six months.



Charcoal filter, Spectra part number FT-FTC-CC

Performing a Fresh Water Flush with a Failed Inlet Pressure Transducer

In the event of a "Service Prefilter" alarm on the remote display **that cannot be cleared by replacing the pre-filters**, the alarm function can be defeated to allow the system to remain in the Auto Store mode until repairs can be facilitated.

Following the instructions in the Settings section of this manual for programming instructions.

YOU MUST BE CERTAIN THAT THE ALARM IS CAUSED BY A FAULTY SENSOR BEFORE DISABLING THE ALARM IN THE SETTINGS MODE. SERIOUS DAMAGE CAN OCCUR.

Spectra Connect Settings

Your new Spectra Connect is designed to make your watermaker easier than ever to operate, maintain and enjoy. This section will guide you through some of the more advanced settings options available.

Always use caution when changing any factory default settings, as serious damage can occur.



The Spectra Connect automatically monitors the operation of the system to ensure a long and trouble-free service life. If an operating parameter changes, the Connect can switch operating modes, shut itself down, or automatically store itself in order to protect your watermaker.

It includes advanced calibration sequences to make proper setup and maintenance of your watermaker easier than ever.

The onboard time clock feature allows for temporary power interruptions without detrimental effects on the system. In some cases your watermaker will continue to function in its last known operating state.

The Spectra Connect has built in data logging, allowing for easy access to historical operating data—which can indicate a wearing component or spares to be carried along before a failure occurs.

Built in warnings for preventative maintenance automatically alert a user of pending maintenance items, helping to keep your watermaker's up-time to 100%! Advance warnings are pre-programmed for Prefilter Life, Clark Pump rebuilds, feed pump heads, membranes, Z-Ion reactor rod life, and carbon filter life. These warnings are resettable, allowing you to perform the maintenance before a catastrophic failure, then reset the interval—so you're always on top of the maintenance cycle!

Spectra Connect Settings, Cont'd

User Settings

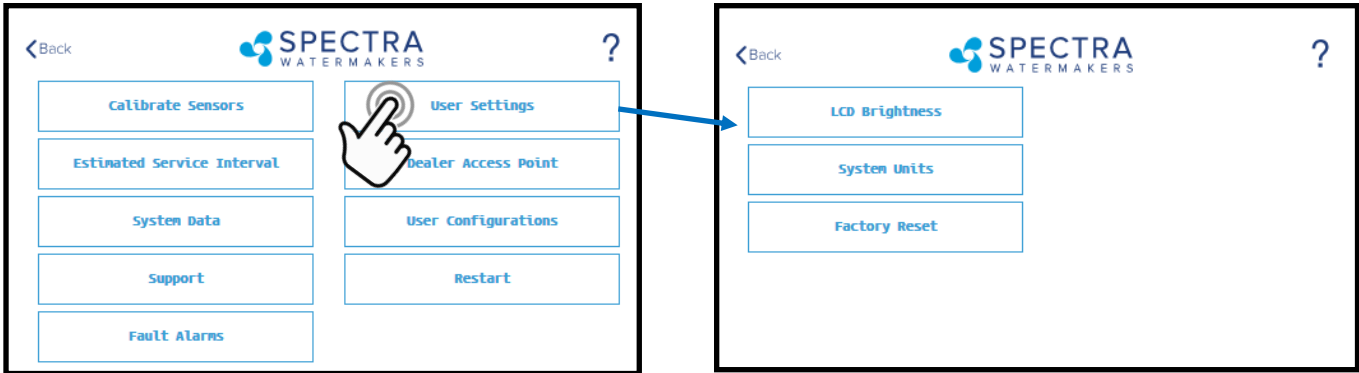

LCD Brightness: Set brightness of the hardwired display(s) from 10—100%

System Units: Change from US Standard units to Metric

Factory Reset: Resets any changed parameters a user has made back to the factory defaults for that configuration.

Fault Alarms

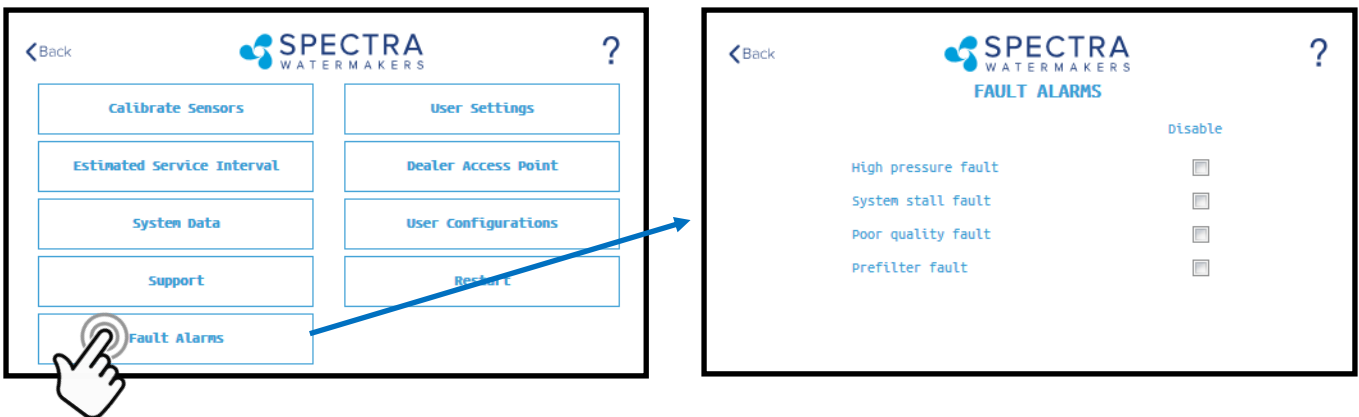

CAUTION!! Never disable a Fault Alarm without being certain that the issue is with a bad sensor. Disabling a fault and running the system can cause serious damage or injury.

High Pressure Fault: Disables the 'High Pressure' shutdown fault in the event of a feed pressure sensor failure.

System Stall Fault: Disables the 'System Stalled' shutdown fault in the event of a failed rotoflow sensor. System stalled alarms occur when the control board does not sense any product water being produced, and shuts down to protect the pump from running dry.

Poor Quality Fault: Disables the 'High Salinity' shut down fault in the event that the salinity probe has failed or cannot be calibrated within range. **NOTE: The diversion valve will always be active when this fault is disabled. ALWAYS VERIFY PRODUCT QUALITY BEFORE DRINKING. Serious health risks may occur.**

Prefilter Fault: Disables the 'Service Prefilter' shut down fault in the event that the boost pressure sensor has failed or cannot be calibrate within range. **CAUTION: Permanent damage to the feed pump can occur if this fault is disabled, use caution when operating this system with this fault disabled.**

Settings

Dealer Access Settings

It is highly recommended that users consult with a factory trained technician before altering any settings behind the 'Dealer Access Point'. **Changing this settings without understanding the full effect of each change can void the warranty of your system, and cause irreparable damage.**

If any settings are inadvertently changed, they can be reverted back to the defaults by using the 'Factory Reset' feature.

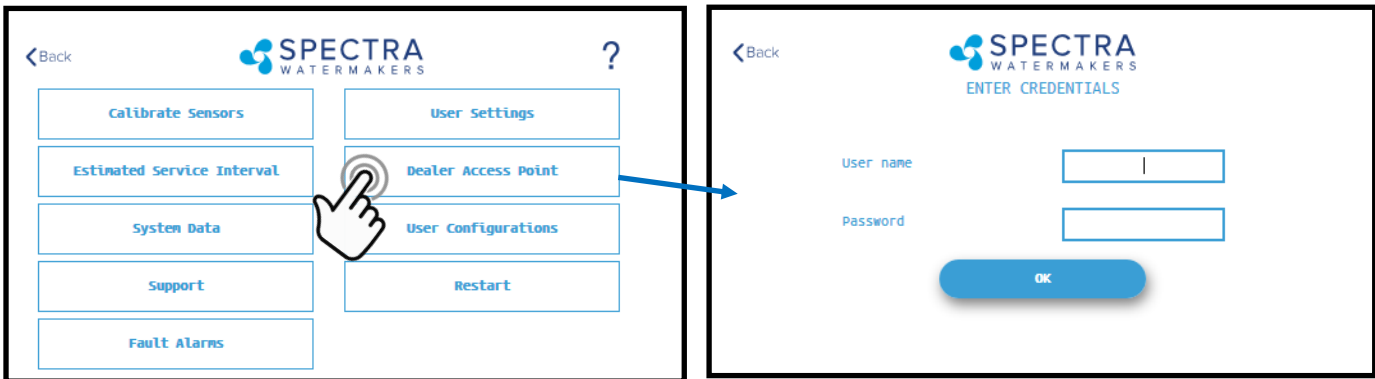

Default Login: admin

Default Password: admin

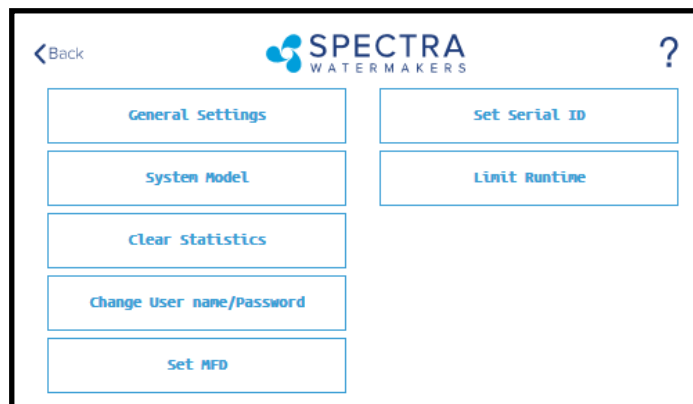

System Model: Configures the Spectra Connect for a different system model from a preset list of options.

Clear Statistics: Resets all of the Estimated Maintenance Intervals back to 100%. This feature should only be used on a brand new system.

Change Username/password: Changes the default username and password. If you forget your changed username and password, a Factory Reset will revert back to the default username and password.

Set MFD: Changes the Manufactured Date on the system. This should only be adjusted if a control board is being replaced on an older system.

Set Serial ID: Changes the Serial Number recorded in the Spectra Connect. This should only be adjusted if a control board is being replaced on an older system.

Limit Runtime: Limits the maximum run time for the system before shutting down and fresh water flushing. Disabling this setting allows the watermaker to be operated 24/7.

Settings

Dealer Access Settings

It is highly recommended that users consult with a factory trained technician before altering any settings behind the 'Dealer Access Point'. **Changing this settings without understanding the full effect of each change can void the warranty of your system, and cause irreparable damage.**

If any settings are inadvertently changed, they can be reverted back to the defaults by using the 'Factory Reset' feature.

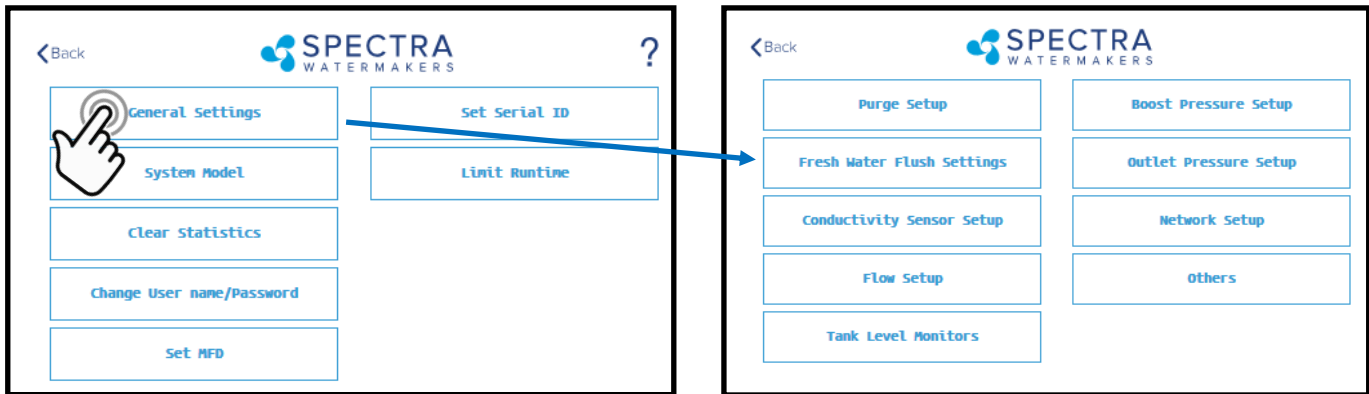

Purge Setup: Adjusts the time and maximum feed pressure allowed for the Purge Mode. **CAUTION: Permanent damage to the membrane can occur if this setting is adjusted. Consult the factory before making any adjustments.**

Fresh Water Flush Settings: Allows adjustment of the fresh water flush duration and the interval between flushes. If the Z-Ion is installed, the Flush Interval should be changed to 30 days.

Conductivity Setup: Allows for enabling or disabling conductivity sensors on the feed water and product water. Set the threshold for the diversion valve to divert water to the tanks.

Flow Setup: Allows the user to adjust the flow sensor settings, or disable a flow sensor circuit altogether. **DO NOT USE THIS SETTING TO CALIBRATE THE PRODUCT FLOW.** Follow instructions on calibrating the flow sensor in this manual.

Tank Level Monitors: Enable and disable the Tank Level Sensors, which read the % remaining in the tank, and the tank switches, which allow the system to turn on/off automatically.

Boost Pressure Setup: Enable alternate Boost Pressure sensors, change the Low Vacuum Limit, or Boost Pressure Setpoint. **CAUTION: Permanent damage to the pump can occur if this setting is adjusted. Consult the factory before making any adjustments.**

Low Vacuum Limit: The minimum boost pressure required at the inlet to the pump. This setting prevents the pump from getting damaged by running under high vacuum. Adjusting it to a lower number increases the risk that the pump will suffer damage during normal operation.

Boost Pressure Setpoint: During startup the controller turns on the boost pump and waits for the Boost Pressure to reach the Boost Pressure Setpoint. If the boost pressure fails to reach this setpoint, then the main pump won't turn on. Reducing the Boost Pressure Setpoint may cause the system to start, then immediately shut down due to low boost pressure.

Outlet Pressure Setup: Set High Pressure Limit, enable alternate high pressure sensors, select pressure sensor scaling. **CAUTION: Permanent damage to the pump can occur if this setting is adjusted. Consult the factory before making any adjustments.**

Network Setup: Enabling the Spectra Connect Wireless access turns on a Power Over Ethernet feature on the wired connection. **ENABLING THIS FEATURE CAN CAUSE SERIOUS DAMAGE TO YOUR SHIP'S NETWORK. DO NOT ENABLE THIS FEATURE WITHOUT CONSULTING A QUALIFIED TECHNICIAN OR THE FACTORY.**

Settings

Dealer Access Settings

It is highly recommended that users consult with a factory trained technician before altering any settings behind the 'Dealer Access Point'. **Changing this settings without understanding the full effect of each change can void the warranty of your system, and cause irreparable damage.**

If any settings are inadvertently changed, they can be reverted back to the defaults by using the 'Factory Reset' feature.

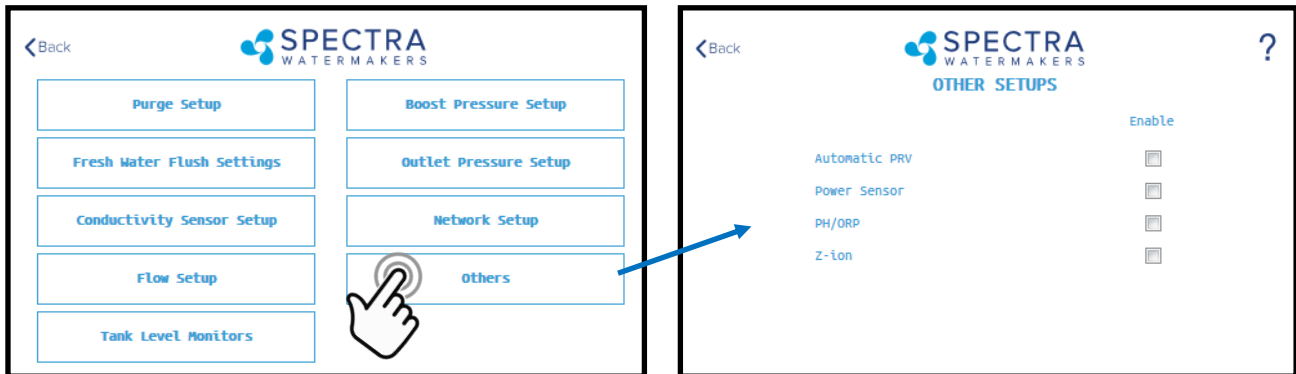

Automatic PRV: Enables an optional Automatic Pressure Relief Valve, after it is installed. This setting should remain off unless you are certain that you have this feature installed on your system.

Power Sensor: Enables or disables an optional power sensor, after it is installed.

PH/ORP: Enables an optional pH or ORP meter, after it is installed.

Z-Ion: Enables or Disables the optional Z-Ion system, after it is installed. If the Z-Ion is enabled, you should also adjust the Flush Interval to 30 days.

Tank Level Monitors

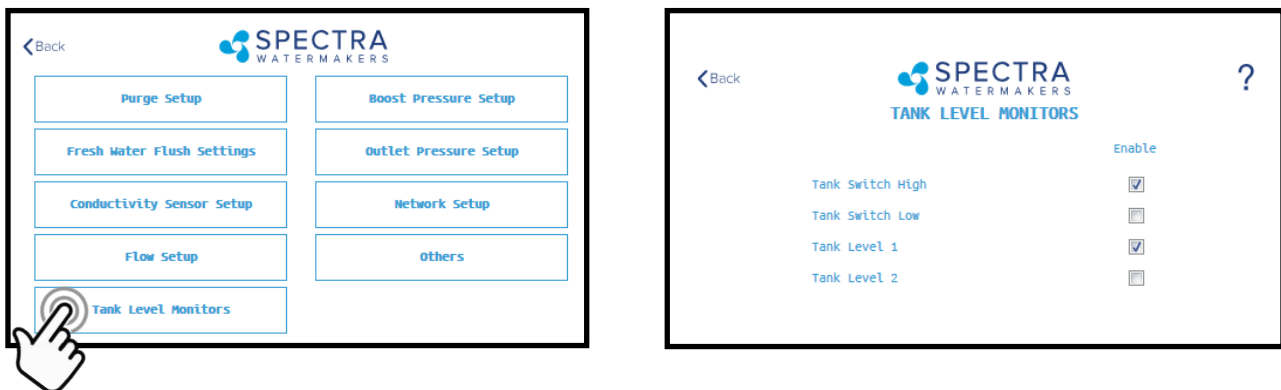

Tank Setup - Enable/disable tank sensors.

Enable Tank Switch High - Enable/disable tank switch high. If this is disabled Auto Fill and Fill Tank run modes will not be available.

Enable Tank Switch Low - Enable/disable tank switch low. If this is disabled Auto Fill mode will not be available. Both High and Low tank switches must be enabled for Auto Fill mode.

Enable Tank Level 1 - Enable/disable tank level sensor 1. If this is disabled there will be no tank level reading and tank level gauge will read "!".

Enable Tank Level 2 - Enable/disable tank level sensor 2..

Fault Handling

Faults are hazardous conditions that might occur during running of your watermaker. The control board has the ability to monitor these faults in real time and take necessary actions to prevent damaging your equipment.

HIGH PRESSURE FAULT

High pressure fault is triggered if

Outlet pressure (Feed/Membrane pressure) > Pressure Limit

If a high pressure fault is triggered, the system goes to low production mode if it is running in high production mode, or stops the operation if it is already running in low production mode. Then the system will begin the Auto Store mode.

Resolutions

Check for kinked or blocked hoses.

Confirm “#3 Sensor PSI High limit” and “#3 Sensor PSI Offset” options on Outlet Settings.

Clean membrane.

SYSTEM STALL FAULT

System stall fault is triggered if

There is no product flow for 1 minute continuously.

If system stall fault is triggered, machine will stop the current run cycle and will prompt to restart. If restarted it will retry the previous running mode. If the stall condition persists even after restart, the system will begin the Auto Store mode.

Resolutions

Confirm product water at membrane endcap.

Check intake line for restrictions, blockages or air leaks.

Close Pressure Relief Valve on Pump.

Confirm controller settings correct.

SERVICE PREFILTER FAULT

The Service Prefilter fault is triggered if

Inlet Pressure(boost pressure) < Low Vacuum Limit

If the Service Prefilter fault triggers, the system goes to low production mode if it is running in high production mode or stops the operation if it is already running in low production mode. Then the system will begin the Auto Store mode.

Resolutions

Change prefilters and the sea strainer screen.

Confirm adequate boost pressure in inlet pressure settings.

Check for obstructions in intake line.

Check sensor for proper operation

POOR QUALITY FAULT

The High Salinity fault triggers if

The Salinity of the product water is above the threshold (measured salinity > Salinity 1 threshold) for more than 8 minutes.

If the High Salinity fault is triggered, the machine will stop the current run cycle and will prompt to restart. If restarted it will retry the previous running mode. If the High Salinity fault condition persists even after restart, the system will begin the Auto Store mode.

Resolutions

Check pump operation - Clark Pump (pressure relief valve closed), Feed Pump (moving water).

Confirm product water quality.

Membrane damage - clean or replace.

Salinity probe out of calibration.

Clean or replace salinity probe.

Wiring Schematic—DC

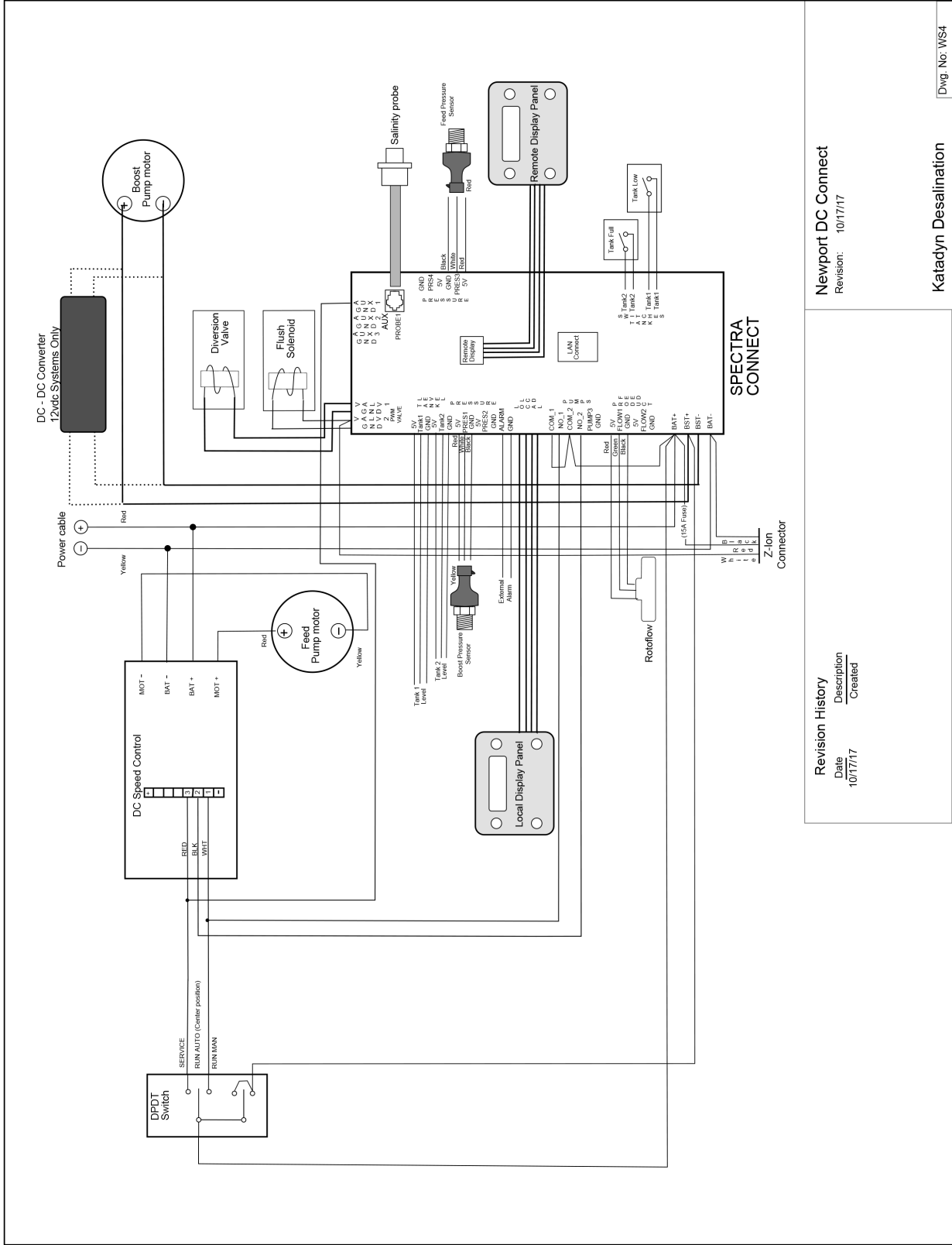

Newport DC Connect
Revision: 10/17/17

Revision History
Date: 10/17/17
Description: Created

Dwg. No. WS4

Katayn Desalination

Electrical Specifications

Operating voltage limits: 10—32vdc

Outputs: 5VDC:— 2000mA Total for all outputs.
VLV 1&2: 1 Amp DC priming valve solenoid.
AUX 1-3: 1 Amp DC auxiliary output.

Never connected anything to the Spectra Connect without factory approval. Serious damage can occur!

Exploded Views and Part Numbers

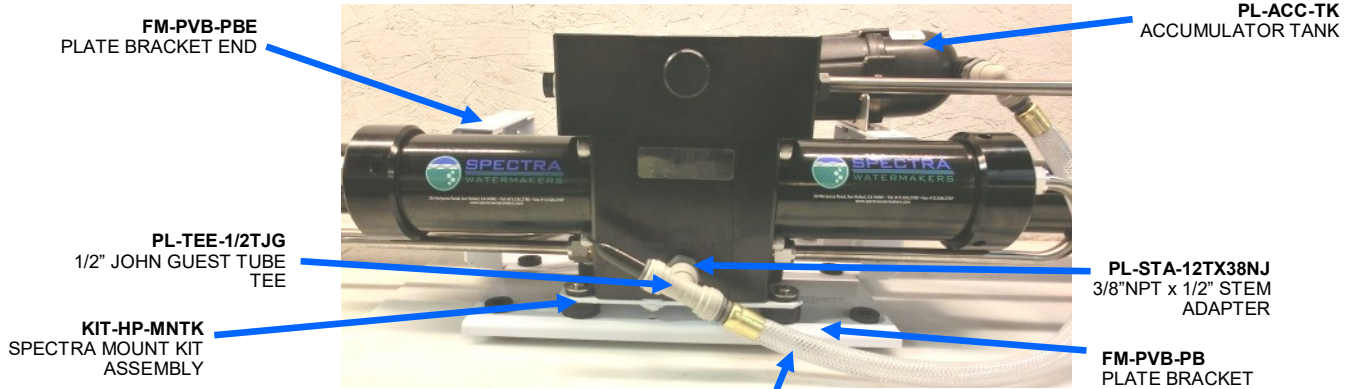

Accumulator Hose:
 20 inches 1/2-inch vinyl hose **PL-HS-1/2VN**
 (2) brass ferrules **PL-HF-.75IDX1BR**
 (2) 1/2-inch hose barb tube adapters **PL-HBA-1/2Tx1/2**
 5 inches of 3/4-inch spiral wrap **EL-LT-3/4SW**
 Hose clamps may be substituted for the brass ferrules, which are crimped on.

PL-TB-HP-HPTVUL
Pump to Pressure Vessel Upper
SS Tube

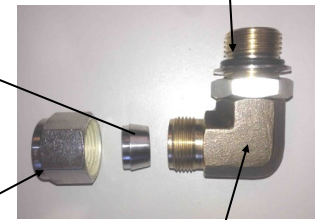
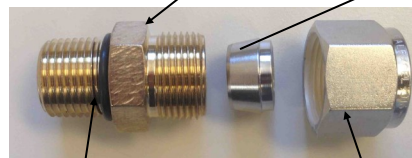
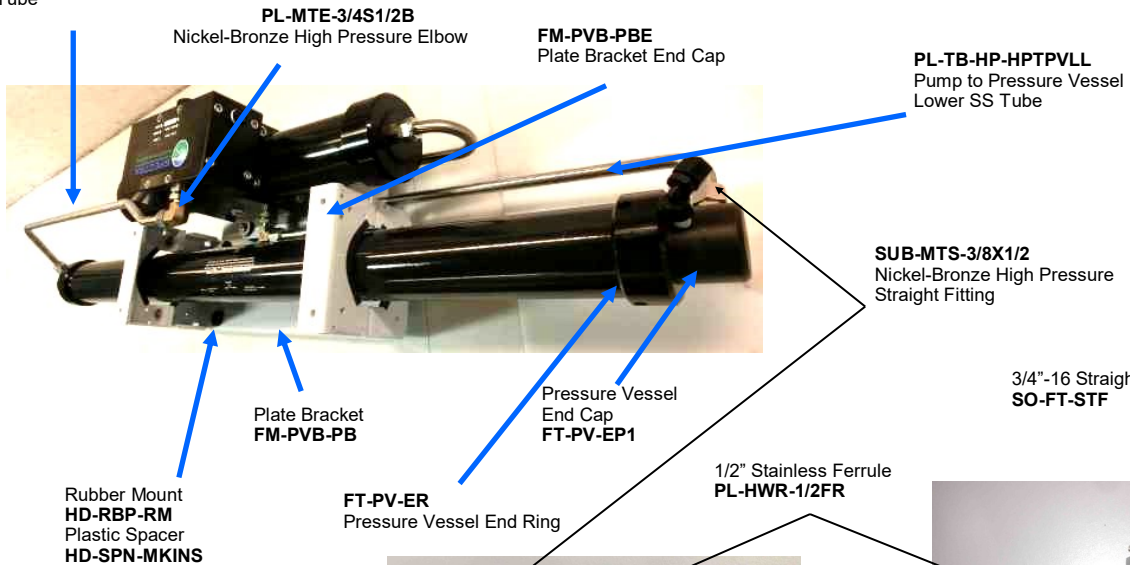

PL-SWF-1/8x1/4J
1/8" NPT to 1/4" Tube
John Guest elbow

FT-PV-ER
Pressure Vessel End
Ring

KIT-PV-25EP1
Pressure Vessel End
Cap Kit

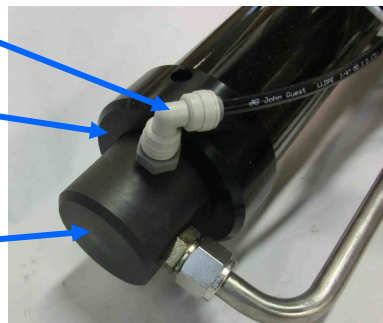

PART NUMBERS

KIT-NP-400C-FPM1 NP-400c FPM 12V



- PL-SWF-3/8X3/8T**
3/8"NPT X 3/8" TUBE
FITTING ELL JG
- PL-SLN-1/4D12M**
1/4" DIVERSION
VALVE 12 V (MNF)
- EL-SSR-150**
PRESSURE TRANSDUCER
(150 PSI)
- PL-HBE-1/2x3/4**
1/2"NPT X 3/4" HOSE
BARB ELL.NYL
- PL-MTE-3/8x1/4J**
John Guest 3/8"NPT x
1/4" tube elbow

- EL-PS-24V240WDC**
DC-DC Step Up Power Supply
24V 240W
- PL-HBE-3/4x3/4**
3/4"NPT x 3/4" hose barb elbow
- FT-FTH-10L3PCS**
10" LOW PRESS. FILTER
HOUSING 3 PCS
- PL-MTE-3/4S1/2B**
3/4"-16S X 1/2" TUBE
90DEG. AL-BRZ
- PL-HS-3/4VN**
3/4" VINYL HOSE

- EL-MTR-PWMA**
MOTOR SPEED CONTROL
- PL-SLN-1/4O12SP**
1/4" 1-WAY SOLENOID
VALVE 12V W/O VB
- SUB-NP-MK2-INTZ**
NP MK-II INTAKE MANIFOLD
- PL-HBS-1/2X5/8**
1/2"NPT X 5/8" HOSE BARB ST
- EL-SSR-IFM**
INLINE FLOW SENSOR
- PL-MTE-3/4S1/2B**
3/4-16 X 1/2" TUBE FITTING
- EL-MPC-SP4**
SALINITY PROBE
- PL-PMP-140MAG**
MAG. DRIVE VANE PUMP
140 GPH
- PL-NLT-1/2LP**
LOW PRESSURE TUBE NYL
- PL-SWF-3/8X1/2T**
3/8"NPT X 1/2" TUBE SWIVEL
ELBOW

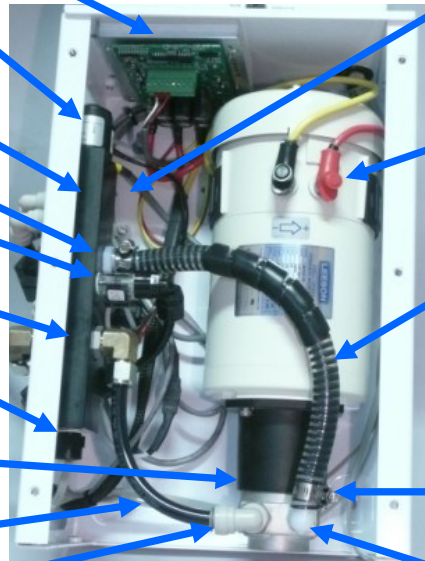

- EL-SSR-ABS**
ABSOLUTE PRESSURE SENSOR
BACK SIDE OF MANIFOLD
- EL-MTR-1/2HP12**
1/2HP MOTOR 12V 2000
RPM 48YC TEFC
OR
EL-MTR-1/2HP24
1/2HP MOTOR 24V, 2000
RPM, 48YC TEFC
- PL-HS-5/8SH**
5/8" SUCTION HOSE
- PL-CLP-10SS**
#10 HOSE CLAMP
- PL-HBE-3/8X5/8**
3/8" X 5/8" HOSE BARB EL

PART NUMBERS

KIT-NP-M2Z-SBPM NP-400 MK-II Z STRANER-BP MODULE



Accumulator

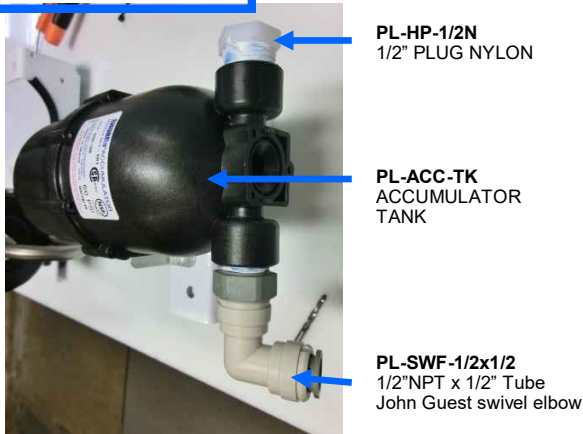

Brine Discharge Quick Connect

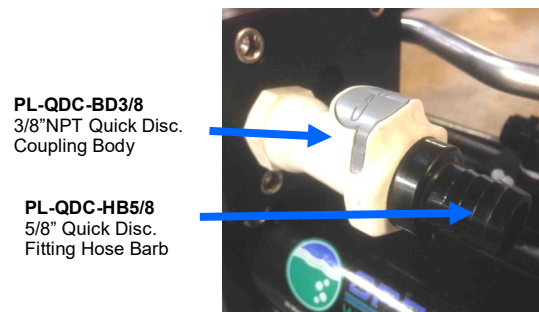

KIT-NP-M2Z-FWF NP-400 MK-II Z FWF MODULE



PART NUMBERS

Control Box

EL-SWT-TSBHC
TOGGLE SWITCH BOOT
SEAL

EL-TS-5000-CTRL
KATADYN-5000
CONTROL BOARD

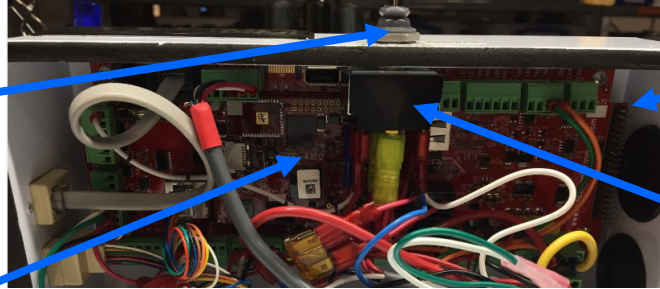

FM-MPC-MPCB
MPC BOX

EL-SWT-TG-DPDT
TOGGLE SWITCH
DP/DT

Hoses and Tubes

Feed Pump to Strainer hose assembly (**SUB-NP-M2Z-FPSL**):

Brass ferrules for 1/2-inch hose
(**PL-HF-.75IDX1BR**)

1/2" HB Quick Disconnect Body
with Valve
(**PL-QDC-1/2HBDWV**)



#6 Hose Clamp
(**PL-CLP-6SS**)

1/2" Vinyl Hose (**PL-HS-1/2VN**)

3/8" T Stem x 1/2 HB Adapter
(**PL-HBA-3/8TX1/2**)

NEWPORT MK-IIZ HP INLET HOSE (**KIT-NP-M2Z-HPIH**):

1/2-inch vinyl hose
(**PL-HS-1/2VN**)

1/2" John Guest stem fitting to
1/2" hose barb adapter
(**PL-HBA-1/2TX1/2**)



Stainless Fitting Hex
Nut
(**PL-HWR-1/2HN**)

1/2" Stainless Ferrule
(**PL-HWR-1/2FR**)

Brass ferrules for 1/2-inch hose
(**PL-HF-.75IDX1BR**)

Note: Hose clamps may be substituted for brass ferrules (which require a special crimper).

Hoses and Tubes cont.

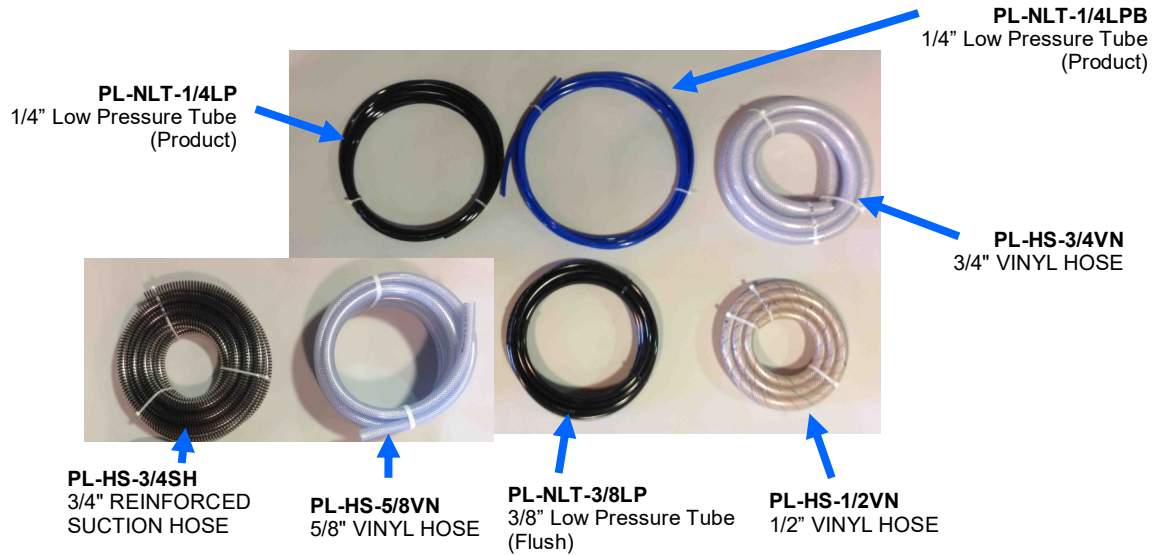

Quick Disconnect Pigtail (installed at "to strainer" fitting on feed pump module):

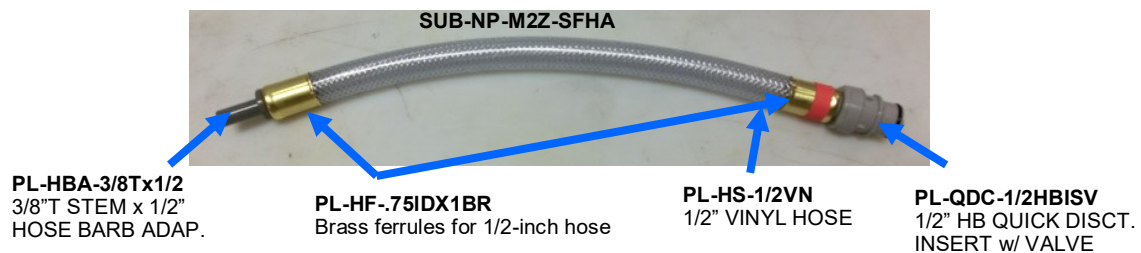

Note: Hose clamps may be substituted for brass ferrules, which require a special crimper.

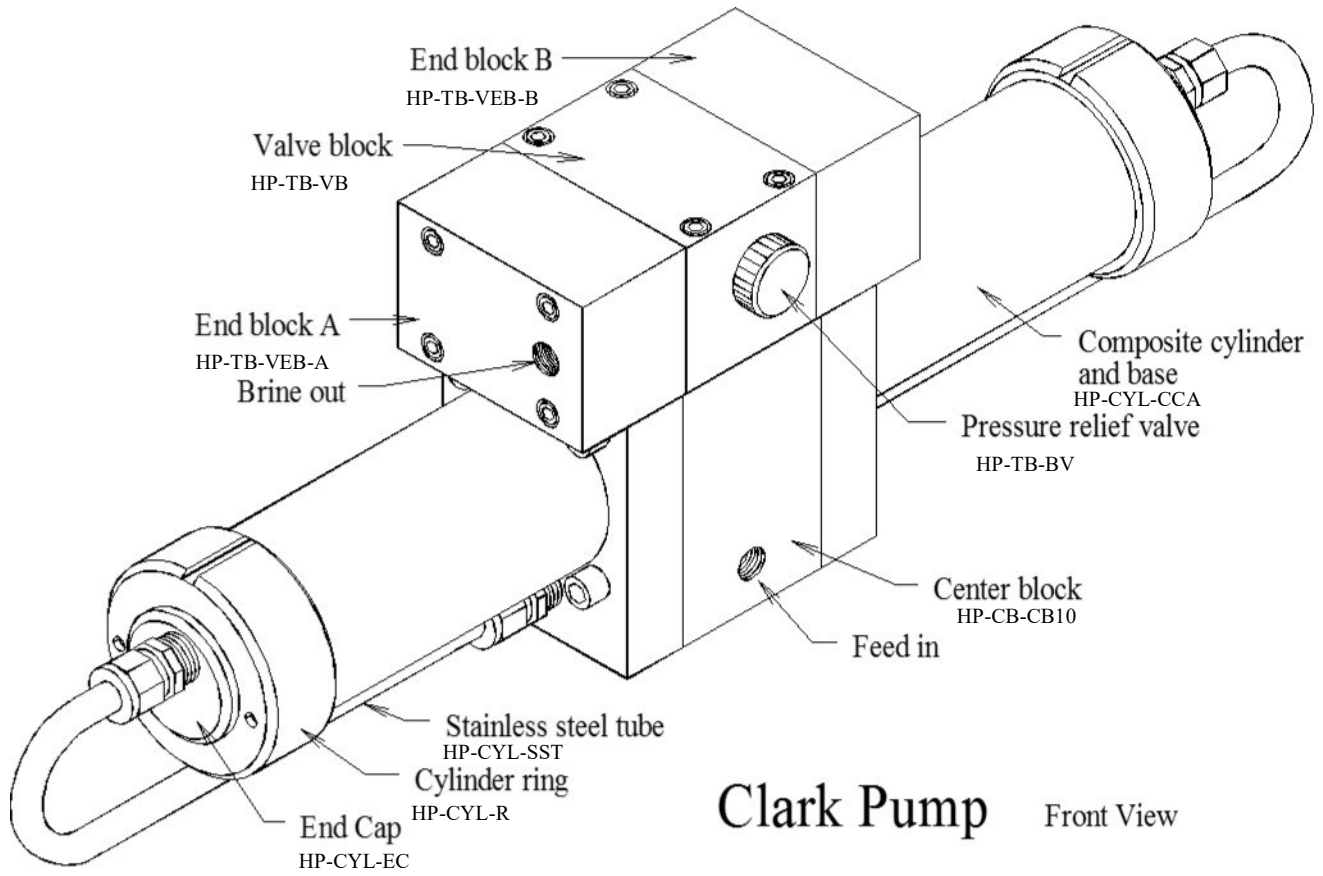

Clark Pump Front View

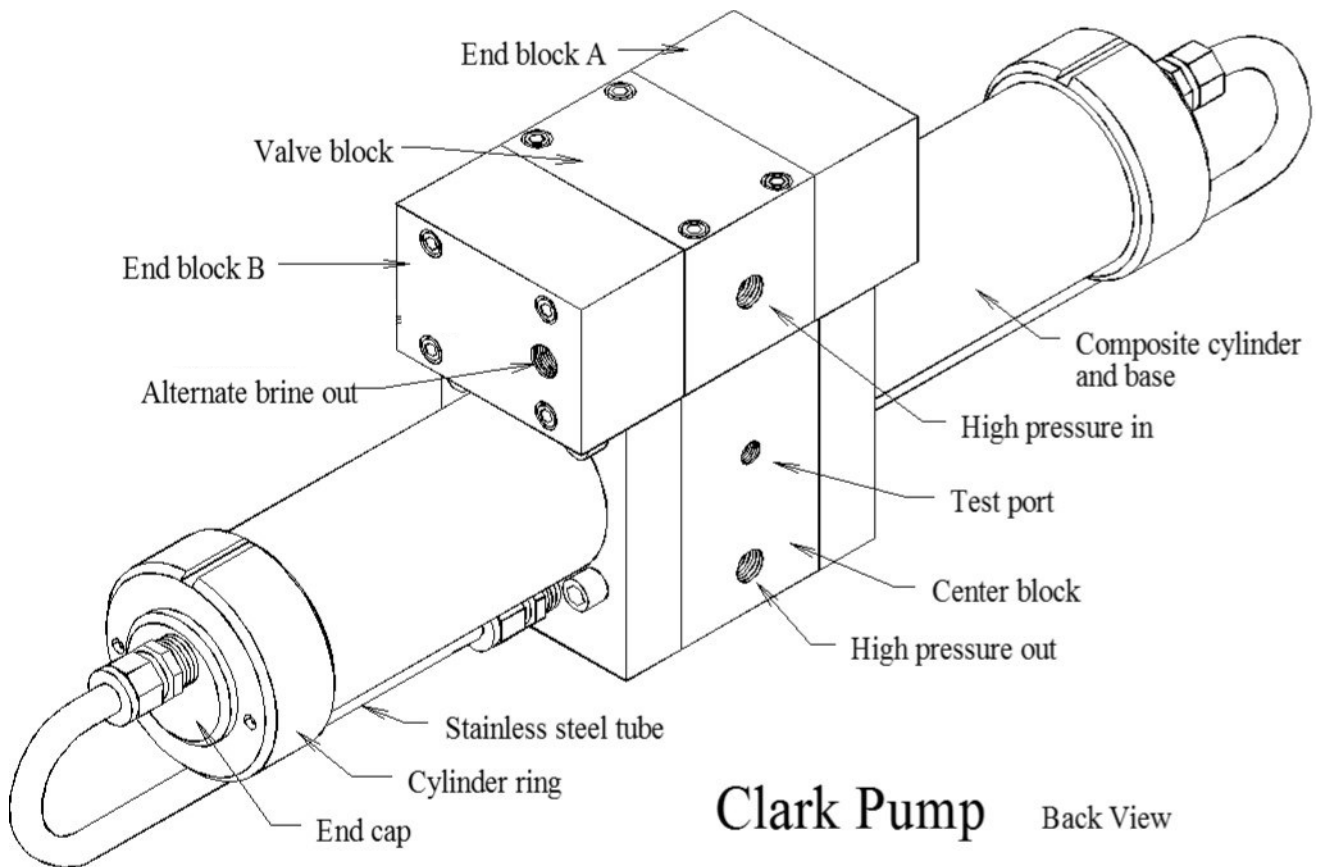

Clark Pump Back View

Spool Assembly
Exploded View

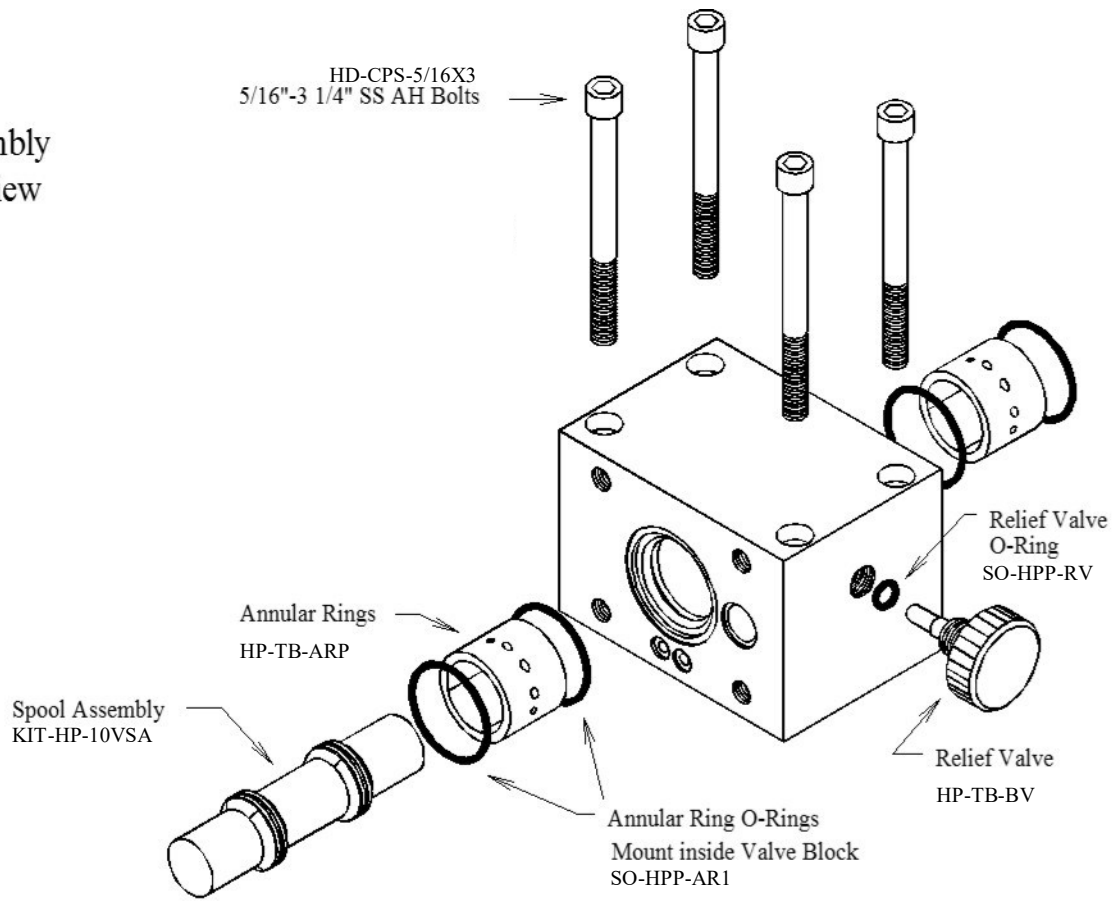

Valve Block

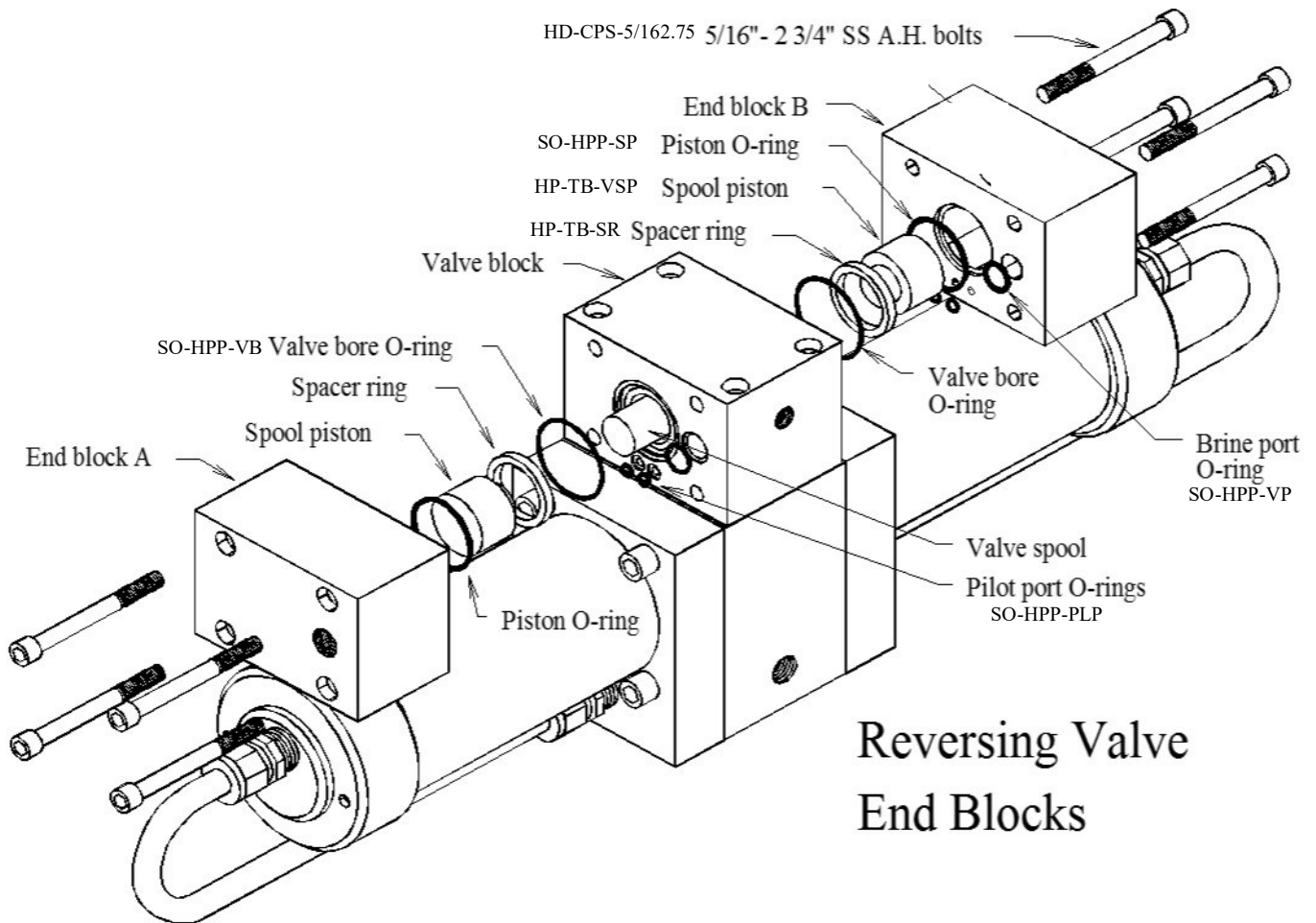

Reversing Valve
End Blocks

Parts

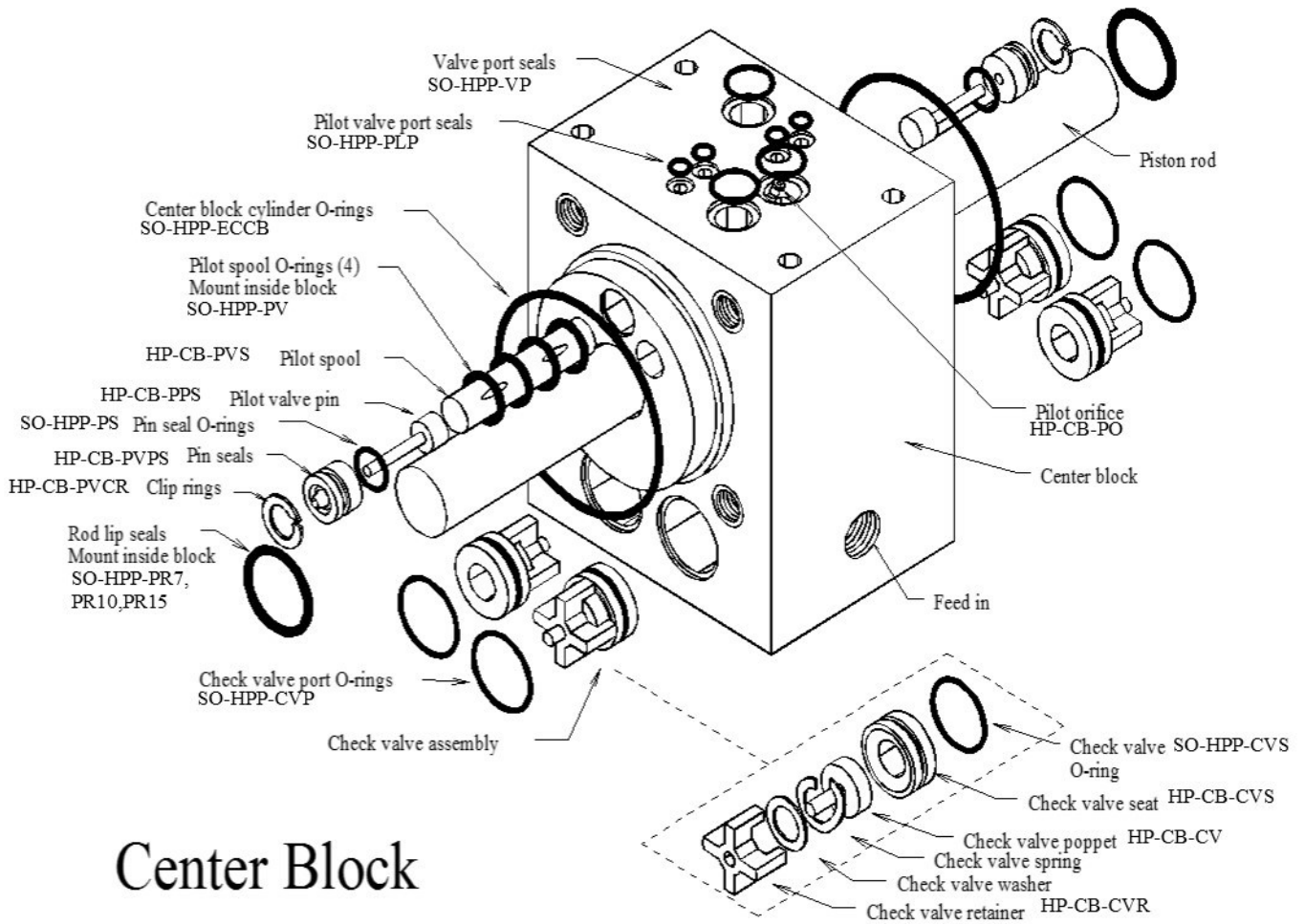

Center Block

Parts

